

4



fogantyúk és fogasok

Tulip	
Fém fogantyúk és bútorgombok	4.15 – 4.70
Rusztikus és porcelán fogantyúk és bútorgombok	4.71 – 4.86
Süllyesztett fogantyúk és profilok	4.87 – 4.112
Fa fogantyúk és bútorgombok	4.113 – 4.118
Gyermek- és m anyag fogantyúk és bútorgombok	4.119 – 4.126
Fogasok	4.127 – 4.144
Marella di jn	
Fém fogantyúk	4.145 – 4.156
Hettich	
Nemesacél fogantyúk	4.157 – 4.158
Fém fogantyúk	4.159 – 4.171

4

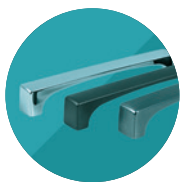

Fogantyúk és fogasok színeinek áttekintése



króm



arany



nemesacél

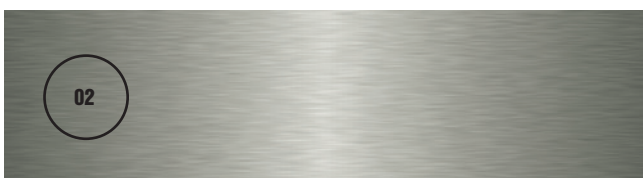

óarany



rozsdamentes acél imitáció



bronz

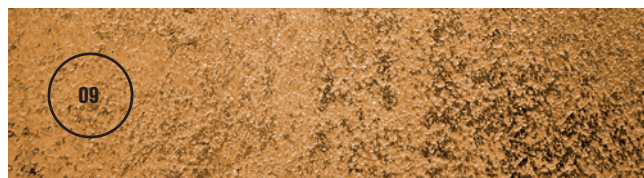

nikkel

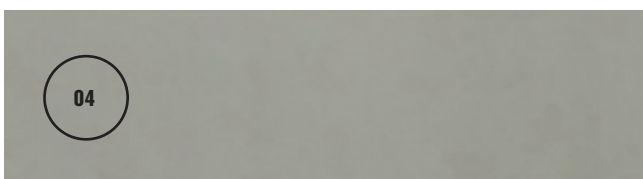

óbronz

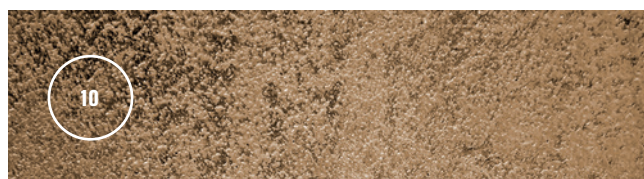

sötét nikkel

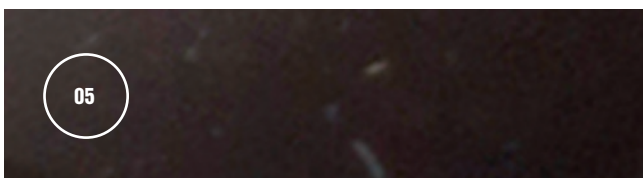

réz



eloxált alumínium



óréz



! A fogantyúk különböző felületkezeléssel rendelkeznek: csiszolt, fényes, matt. Az egyes színek és dekorok a beszállítótól függően különbözőek lehetnek.

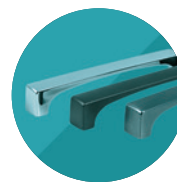

ezüst



barna

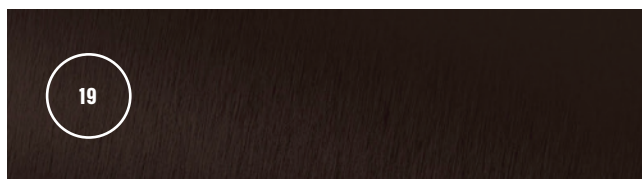

cink



fehér

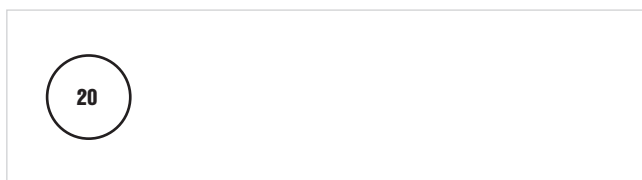

ócink



fa



antracit



műanyag



fekete



porcelán

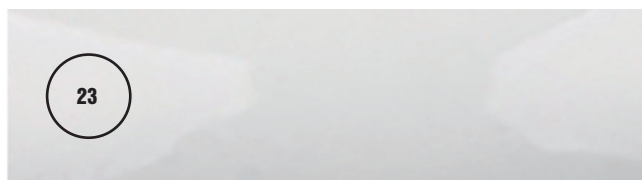

ófekete

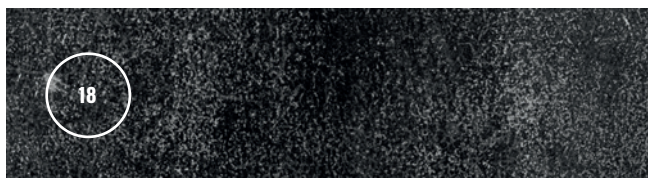

bőr





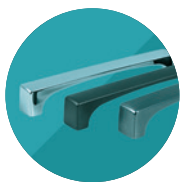

































❗ A fogantyúk különböző felületkezeléssel rendelkeznek: csiszolt, fényes, matt. Az egyes színek és dekorok a beszállítótól függően különbözőek lehetnek.



Fogantyúk és fogasok áttekintése



	Aboa	4.171		Anetta	4.95		Arnum	4.157		Balo XL	4.130
	Acara	4.31		Anita	4.58		Arpi	4.143		Bari	4.29
	Acri	4.19		Anzio	4.157		Art Deco	4.151		Barra	4.144
	Adam	4.117		Anzio	4.166		Asama	4.42		Basilia	4.163
	Aira	4.53		Aramis M	4.156		Avoca	4.90		Bastone	4.35
	Alma	4.43		Aramis S	4.156		Bala	4.118		Beam	4.114
	Almus	4.164		Arco	4.28		Baldone	4.167		Beatrice	4.29
	Andrea	4.28		Arco BM	4.150		Balmo	4.168		Bella	4.19
	Andrea	4.28		Argus X	4.40		Balo	4.130		Belluna	4.133

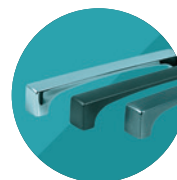

Belluna XL 4.133



Beluga 4.41



Bench 4.16



Berga 4.114



Besina 4.52



Beta 4.57



Bones 4.22



Bones 4.22



Bosa 4.154



Bottone 4.122



Brera 4.149



Buena 4.160



Bustyna 4.116



Caleido 4.149



Caleido 4.149



Cana 4.120



Carina 4.38



Carpi 4.88



Carpo 4.139



Catana 4.163



Cesaro 4.94



Collet 4.68



Columnae 4.152



Columnae 4.152



Comola 4.98



Cona 4.79



Concava 4.94



Conic 4.16



Cordoba 4.59



Coria 4.168



Corsica 4.78



Cottage 4.23



Cottage 4.23



Country 4.80



Country 4.80



Cristina 4.29



Cubic 4.31



Curu 4.75



Curu 4.75



Cute 4.121



Cute 4.121



Dada 100 4.26









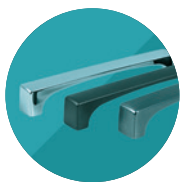





































Dalo 4.53



Dara 4.54



 Darec 4.136	 Elipse 4.50	 Extendo XL 4.135	 Franca 4.138
 Darec XL 4.136	 Ema 4.123	 Fano 4.103	 Francesca 4.44
 Davide 4.36	 Ema 4.123	 Fera 4.134	 Funga 4.120
 Dax 4.135	 Empoli 4.169	 Fermo 4.162	 Galati 4.161
 Defence 4.150	 Ena 4.32	 Filip 4.128	 Galka 4.66
 Derby 4.23	 Enuca 4.20	 Fiona 4.50	 Gela 4.161
 Dona 4.134	 Enza 4.62	 Flora 4.124	 Geneda 4.60
 Dora 4.61	 Enza 4.62	 Fisk 4.124	 Genoa 4.165
 Doris 4.131	 Eslinga 4.170	 Flata 4.103	 Glen 4.132
 Dyan 4.134	 Evan 4.65	 Foka 4.35	 Glen XL 4.132
 Egara 4.163	 Extendo 4.135	 Frame 4.49	 Gliss 4.89

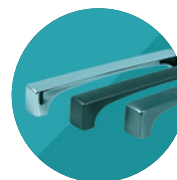

	Gola	4.105		Hrazda	4.33		Inside	4.89		Juvia	4.102
	Graffito	4.44		Hytech	4.45		Into	4.126		Juvia II	4.102
	Grenda	4.19		Chalcis	4.167		Intra	4.166		Kamina	4.51
	Haida	4.169		Chat	4.125		Iroko	4.64		Kamota	4.37
	Halena	4.52		Ibika	4.55		Isola	4.46		Kaniva	4.90
	Halti	4.21		Ida	4.53		Iwo	4.135		Kara L	4.131
	Hana	4.90		Ilan	4.138		Jacek	4.117		Kara M	4.131
	Helena	4.96		Ilan XL	4.138		Jakoto	4.45		Kara S	4.131
	Honza	4.133		Iilita	4.98		Josa	4.39		Kentucky	4.24
	Honza XL	4.133		Iluna	4.55		Jota	4.65		Kentucky	4.24
	Hrazda	4.33		Inclina	4.47		Jura	4.117		Ketina	4.48

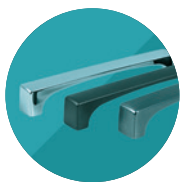

Kewina 4.56



Koby 4.64



Kofu 4.32



Kutta 4.63



Kutta 4.63



Kvadra 4.49



Lacata 4.37



Lama 4.146



Lamezia 4.167



Large 4.126



Laura 4.25



Laura 4.25



Laura 4.132



Lenis 4.155



Lenis 4.155



Lerico 4.140



Level 4.128



Likano 4.45



Lila 4.34



Lineae 4.148



Linea 4.22



Livorno 4.139



Locarno 4.74



Locarno 4.74



Locarno 4.141



Lokuta 4.64



Luca 4.20



Lucata 4.100



Luda 4.58



Lugo 4.141



Lugo XL 4.141



Luna 4.67



Lungo 4.103



M306 4.125



Macis 4.155



Macis 4.155



Madrid 4.93



Malada 4.61



Malena 4.94



Maluka 4.97



Mane 4.91



Marca 4.42



Marcel 4.136



Marcel XL 4.136

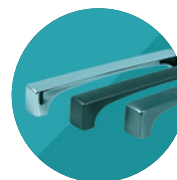

	Marell	4.128		Mateo	4.70		Misura	4.88		Narni	4.170
	Margarita	4.83		Mela	4.137		Modo Q	4.120		Narona	4.166
	Margarita	4.83		Mella	4.17		Modo R	4.121		Nave	4.98
	Margarita	4.83		Mella	4.17		Monacum	4.158		Nidum	4.170
	Margarita	4.84		Menfi	4.74		Murero	4.142		Nodie	4.66
	Margarita	4.85		Menfi	4.74		Murero XL	4.142		Nomina	4.55
	Margarita	4.85		Menusa	4.38		Musina	4.54		Nubia	4.162
	Mariba	4.51		Merita	4.48		Muso	4.140		Oasi	4.156
	Marina	4.36		Messana	4.169		Muta	4.41		Oblong	4.115
	Maritta	4.102		Metra	4.114		Nagisa	4.35		Oga	4.42
	Marusa	4.56		Misia	4.164		Nakana	4.26		Olza	4.117

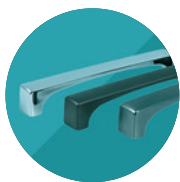

Omono 4.49



Orinoco 4.97



Orio 4.143



Orio XL 4.143



Ota 4.67



P431 4.123



P439 4.123



P603 4.125



Padova 4.60



Palin 4.52



Palla 4.124



Pamil 4.51



Panel 4.91



Panel F 4.91

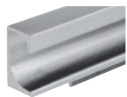

Paolo 4.101



Pari 4.20



Paris 4.86



Paris 4.86



Patric 4.48



Paura 4.50



Pavel 4.144



Peca 4.30



Pelena 4.60



Peneta 4.55



Penka 4.32



Pera 4.129



Pesara 4.93



Petaro 4.46



Petr 4.144



Petros 4.139

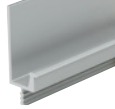

Piano 4.103



Piombina 4.57



Pista 4.96



Porta 4.34



Portos 4.93



Prince 4.149



Prisma 4.69



Raka 4.39



Ramara 4.99



Rana 4.124



Rapallo 4.137



Rapid 4.97



Recife 4.41



Resina 4.17

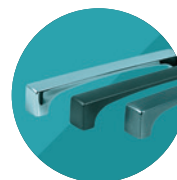

Reta 4.27



Rianna 4.102



Ring 4.92



Ring F 4.92



Rini 4.129



Rini XL 4.129



Roberto 4.139



Rocata 4.25



Rocata 4.132



Rodoso 4.51



Rokos 4.137



Roma 4.18



Romina 4.27



Rosa 4.82



Rotonda 4.57



Rubico 4.142



Rubico XL 4.142



Ruda 4.56



Rulida 4.95



Ruona 4.56



Ruota 4.62



Ruota 4.63



Rusa 4.54



Rustik 4.73



Rustik 4.73



Ruza 4.65



Ruza 4.130



Sakata 4.36



Sakita 4.59



Salacia 4.164



Salona 4.168



Sara 4.82



Savona 4.26



Scala 4.43



Scoop 4.18



Sekol 4.76



Sekol 4.76



Selena 4.59



Sema 4.44



Sempli 4.40



Sempli 4.40



Serena 4.76



Serena 4.76



Setan 4.70

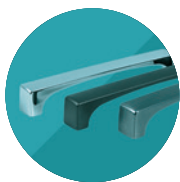

Shell 4.79



Shellby 4.88



Sirius 4.152



Sirius 4.152



Sita 4.54



Sola 4.118



Sophia 4.99



Sosa 4.37



Spaccata 4.122



Spaccata 4.122



Spira 4.171



Square 4.115



Stamp 4.79



Stela 4.82



Stockholm 4.77



Stockholm 4.77



Sulky 4.24



Swift 4.89



Swoosh 4.18



Taca 4.30



Taca 4.30



Taloma 4.46



Tamos 4.140



Taper 4.115



Tarana 4.31



Tarasa 4.138



Tenga 4.35

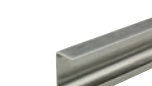

Teppo 4.101



Timina 4.58



Tinto 4.68



Tomic 4.70



Tomo 4.73



Tomo 4.73



Tonda 4.147



Toronto 4.79



Touch-in 4.171



Touch-in 4.171



Towada 4.38



Towelo 4.144



Trama 4.146



Treka 4.143



Trias 4.137



Trogola 4.116



Tucana 4.66

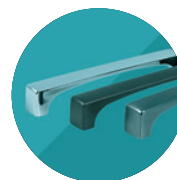

	Turìa	4.77		Utara	4.92		Viaggio	4.151		Virella M	4.72
	Tuvola	4.75		Vali	4.28		Victoria	4.80		Virella S	4.72
	Tuvola	4.75		Vantania	4.165		Victoria	4.80		Vitruvio	4.146
	Ukuda	4.70		Vasca	4.116		Victory	4.134		Wakano	4.45
	Ulica	4.39		Venice	4.154		Vigilia	4.165		Wake	4.16
	Uliko	4.77		Venice O	4.154		Vintage	4.85		Wave	4.115
	Umberto	4.29		Venice R	4.154		Vintage	4.86		Whale	4.67
	Unesa	4.59		Venusia	4.169		Vintage O	4.69		Zara	4.23
	Unico	4.140		Vereca	4.61		Vintage R	4.69		Zito	4.48
	Unta	4.96		Verona	4.27		Vintage ST	4.69		Zola	4.68
	Uroso	4.52		Viaggio	4.151		Virella L	4.72		Zuzana	4.46

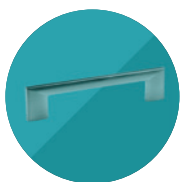

FOGANTYÚK ÉS FOGASOK

fém fogantyúk és bútorgombok

TULIP

Tulip fém fogantyúk és bútorgombok



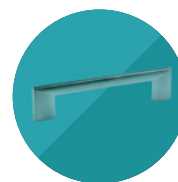



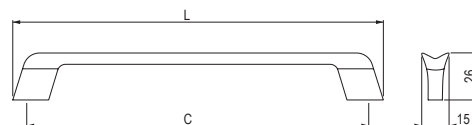

Wake

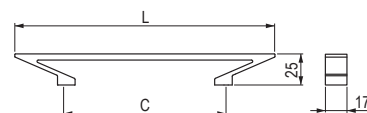

	furattávolság C (mm)	L hossz (mm)
401562	160	180
401563	320	340





Bench



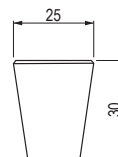

			furattávolság C (mm)	L hossz (mm)
401564	401568	401566	64	141
401565	401569	401567	128	205

Conic

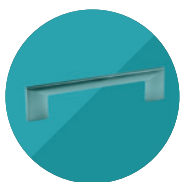
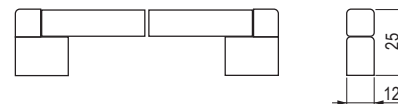

			
401555	401556	401557	401558

**N Resina**

 fekete matt	furattávolság C (mm)	L hossz (mm)
399508	128	152
399509	160	184
399510	192	216
399511	224	248
399512	256	280
399513	320	344
399514	384	408
399515	448	472
399516	480	504
399517	672	696
399518	736	760
399519	832	856
399520	960	984
399521	1056	1080
399522	1184	1208

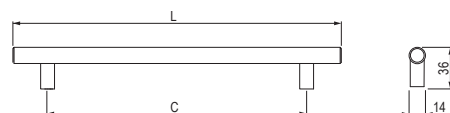
N Mella

 fekete matt	 arany matt	furattávolság C (mm)	L hossz (mm)
396164	396165	160	220

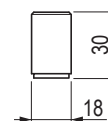

N Mella

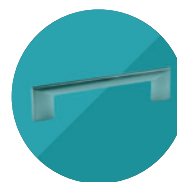
 fekete matt	 arany matt
396166	396167



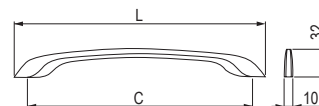



Roma

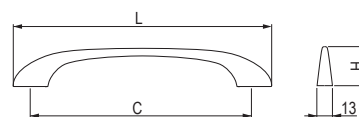

			L hossz (mm)
króm fényes	rozsdamentes acél imitáció	furattávolság C (mm)	
192326	192327	192	246
192328	192329	288	346



Swoosh

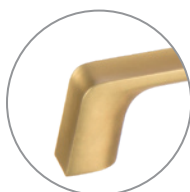
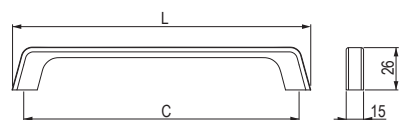

				L hossz (mm)	magasság H (mm)
króm fényes	arany matt	réz matt	furattávolság C (mm)		
340551	351827	351825	160	200	30
340584	351828	351826	320	360	32

Scoop



			L hossz (mm)
arany matt	réz matt	furattávolság C (mm)	
351843	351845	160	180
351844	351846	320	340

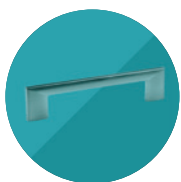

N Bella

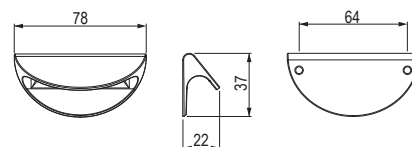

arany matt

396163

N Acri

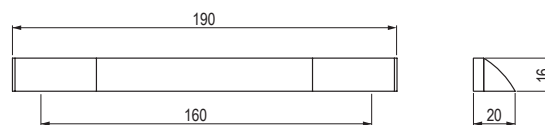

nikkelt csiszolt

398580



feke matt

398581



sötét nikkelt
fényes

398582



arany matt

398583



fehér matt

398584

N Grenda

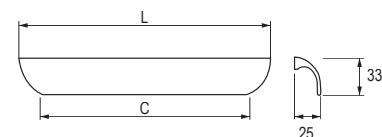

rozsdamentes
acél imitáció

206141



csiszolt fekete

392708

furattávolság
C (mm)

64

L
hossz
(mm)

114

206142

392710

128

178

206146

392714

320

370

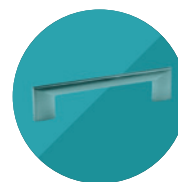

Enuca

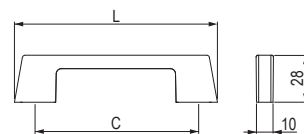
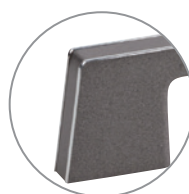
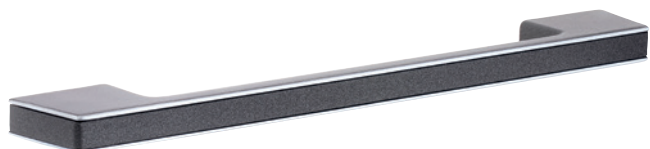

 antracit/ króm fényes	furattávolság C (mm)	L hossz (mm)
284095	96	121
284096	128	143
284097	160	190
284098	224	254
284099	320	352

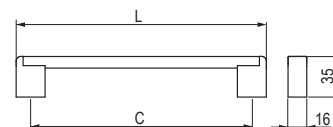

 Pari

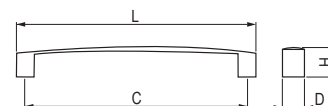

óbronz/ rozsdamentes acél imitáció	furattávolság C (mm)	L hossz (mm)
399830	160	173
399831	320	333
399832	448	461

Luca



 króm matt	 rozsdamentes acél imitáció	 óarany	furattávolság C (mm)	L hossz (mm)	D szélesség (mm)	H magasság (mm)
224941	224945	359879	128	141	21	22
224942	224946	359881	160	172	21,5	23
224943	224947	359882	224	235	21,5	23
224944	224948	359883	256	267,5	20	22,5

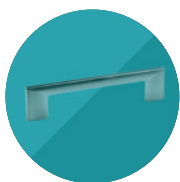

Halti

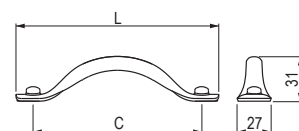

ófekete

351829

ócink

351831

óréz

351832furattávolság
C (mm)

128

L
hossz
(mm)

158

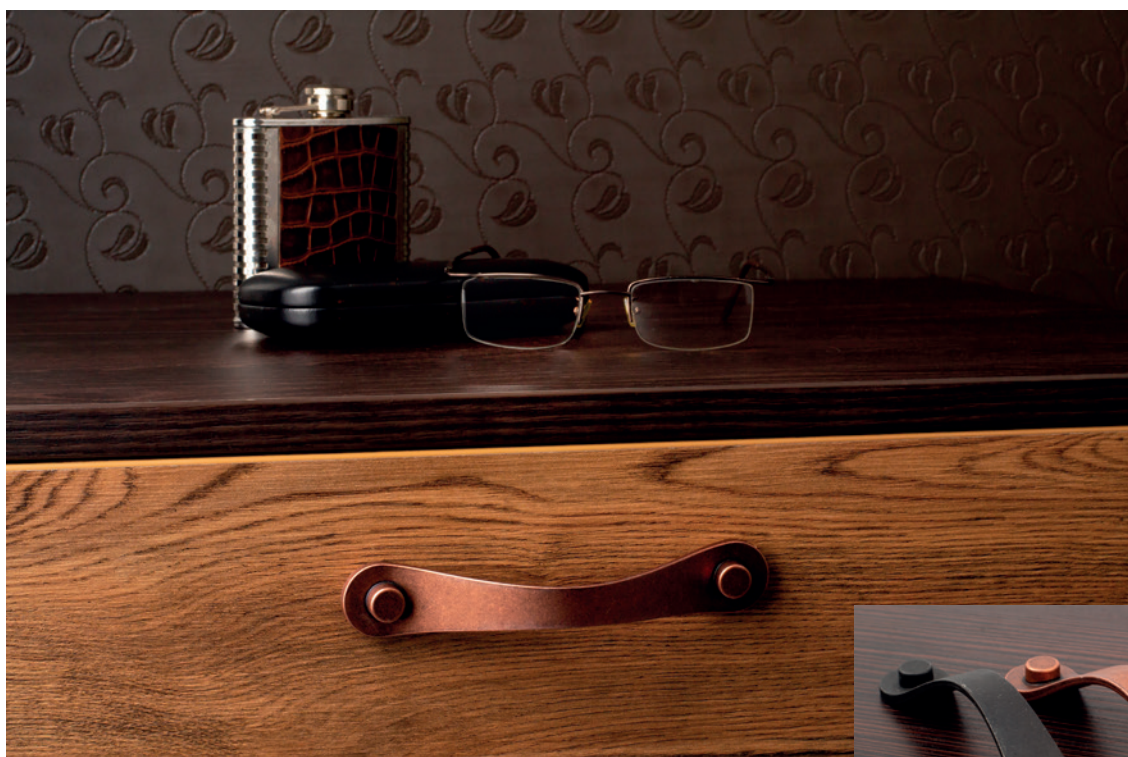

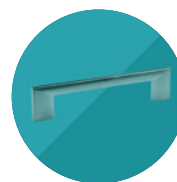

Bones

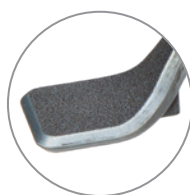
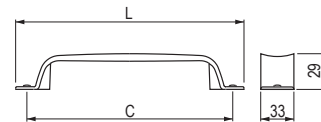

 ófekete	 ócink	furattávolság C (mm)	L hossz (mm)
351837	351839	128	200

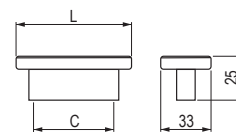

Bones

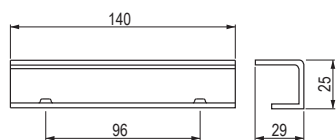

 ófekete	 ócink	furattávolság C (mm)	L hossz (mm)
351840	351842	32	50

Linea



 ófekete	 ócink
204085	204087

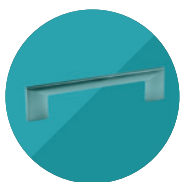

Zara

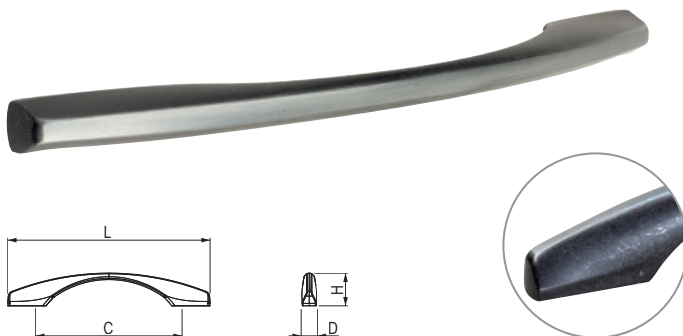

ófekete	furattávolság C (mm)	L hossz (mm)	D szélesség (mm)	H magasság (mm)
284041	128	170	12	27
284042	160	202	12	28
284043	256	298	13	29
284044	320	362	13	29

Cottage

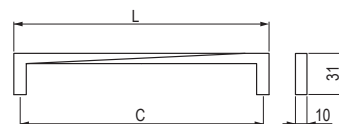

ócsink	furattávolság C (mm)	L hossz (mm)
42013	128	138
42011	160	170

Cottage

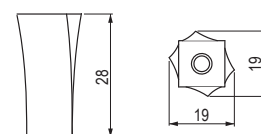

ócsink

42015

Derby

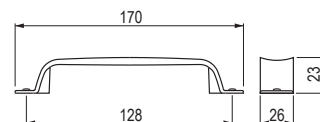

ófekete

202825



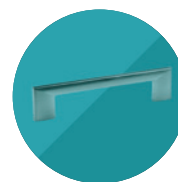

ócsink

202827



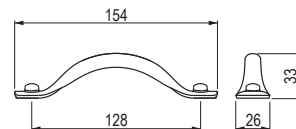

Sulky



	
ófekete	ócinke
202828	202830

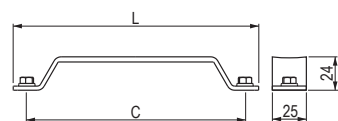

Kentucky

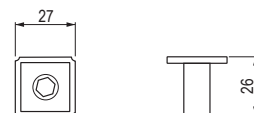

		furattávolság C (mm)	L hossz (mm)
ófekete	ócinke		
202844	202846	160	180
202831	202843	192	212

Kentucky



	
ófekete	ócinke
351834	351836

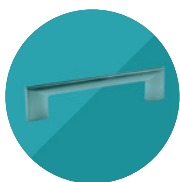

Rocata

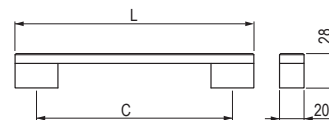
Rocata fogas
(old. 4.132)

● fekete matt	furattávolság C (mm)	L hossz (mm)
284104	160	203
284105	224	267
284106	320	363
284107	480	523

Laura

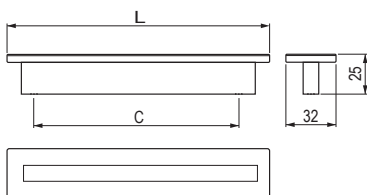
Laura fogas
(old. 4.132)

● fekete matt	furattávolság C (mm)	L hossz (mm)
320989	32	60
320991	128	168
320992	160	200
320993	224	264
320994	320	360
320995	448	488

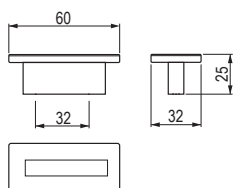

Laura

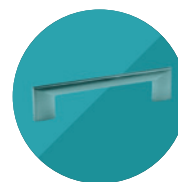
Laura fogas
(old. 4.132)fekete
matt**320989**



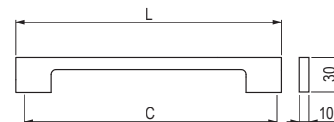
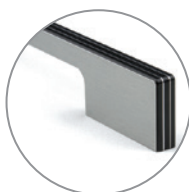





Dada 100

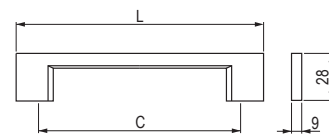

		furattávolság C (mm)	L hossz (mm)
fekete matt	rozsdamentes acél imitáció		
157489	157494	160	240
157490	157495	192	272
157491	157496	256	336
157492	157497	320	400
157493	157498	384	464

Nakana



						furattávolság C (mm)	L hossz (mm)
fehér fényes	fekete fényes	fekete matt	króm matt	nikkel csiszolt	króm fényes		
343561	343563	401576	290737	290750	290754	96	129
343564	343565	401577	290740	290738	290739	128	161
343566	343567	401578	303315	303316	303314	160	193
343568	343569	401579	290743	290741	290742	192	225
343570	343571	401580	290746	290744	290745	256	289
343572	343573	401581	290749	290747	290748	320	353

Savona

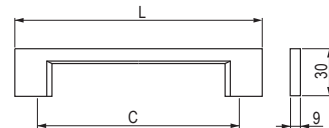

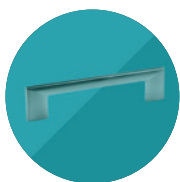

	furattávolság C (mm)	L hossz (mm)	D szélesség (mm)	H magasság (mm)
ófekete				
351876	160	172	9	30
351877	192	204	9	30



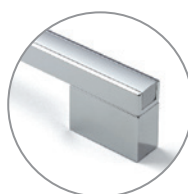
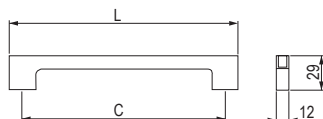
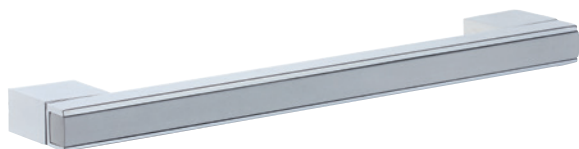

Verona



			
króm fényes/ eloxált alumínium	króm fényes/ rozsdamentes acél imitáció	furattávolság C (mm)	L hossz (mm)
195116	195117	128	139
195119	195120	160	171
195122	195123	192	203
195125	195126	224	235
195128	195129	320	331
195131	195132	448	459
195134	195135	576	587
195137	195138	672	683
195140	195141	736	747

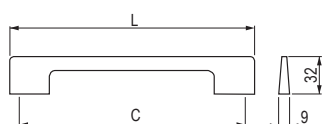

Romina

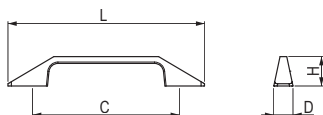

			
króm fényes	rozsdamentes acél imitáció	furattávolság C (mm)	L hossz (mm)
202984	202989	192	212
202986	202990	256	276
202987	202991	320	340
202988	202992	448	468

Reta



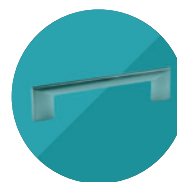

					
antracit	rozsdamentes acél imitáció	furattávolság C (mm)	L hossz (mm)	D szélesség (mm)	H magasság (mm)
284058	284064	96	156	17	25
284059	284065	128	174	17	26
284060	284066	160	211	18	27
284061	284067	256	311	20	28
284062	284068	320	377	20	28



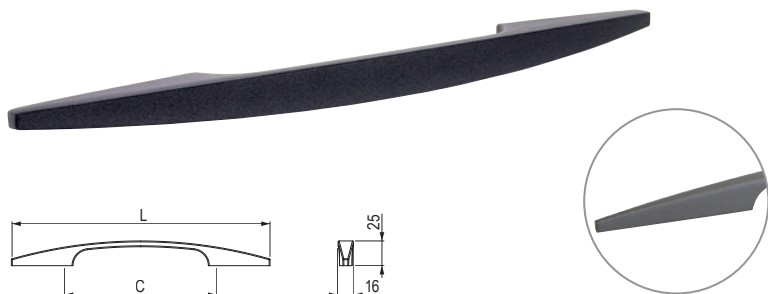

Arco

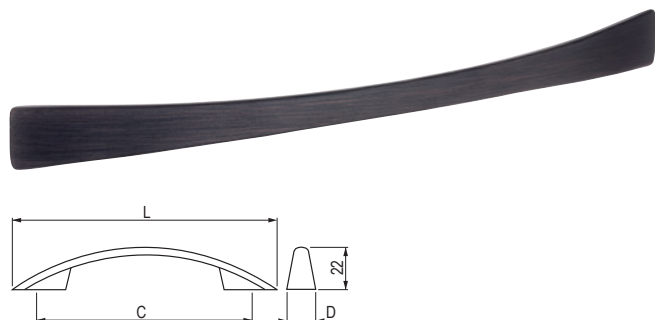

 antracit	 rozsdamentes acél imitáció	furattávolság C (mm)	L hossz (mm)
284045	284049	128	248
284046	284050	160	272
284047	284051	256	340
284048	284052	320	410

Vali



 órész sötét	 ócink csiszolt	furattávolság C (mm)	L hossz (mm)	D szélesség (mm)
226960	226963	96	140	15
226961	226964	128	174	16
226962	x	160	206	16

Andrea

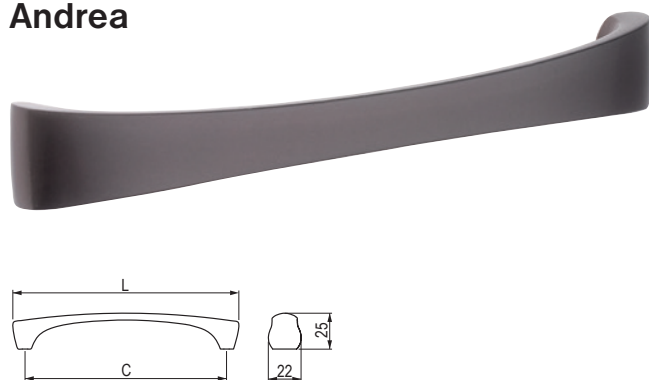

 sötét nikkelt matt	furattávolság C (mm)	L hossz (mm)
351947	96	110
351948	128	142
351949	160	174

Andrea

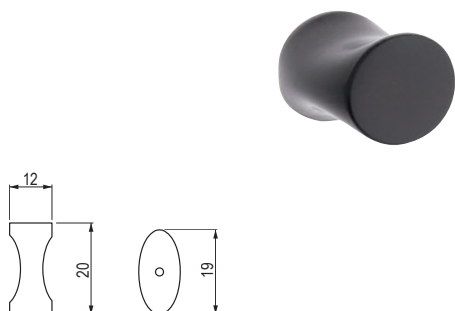

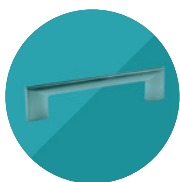

 sötét nikkelt matt
351946



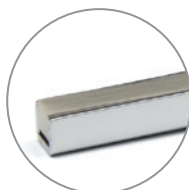
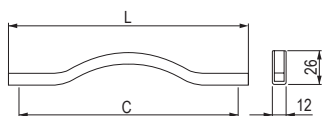

Beatrice



			L hossz (mm)
króm fényes/ rozsdamentes acél imitáció	króm fényes/ króm csiszolt	furattávolság C (mm)	
192351	192353	224	236
192352	192354	320	332

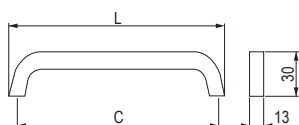

Umberto



			L hossz (mm)
króm fényes	rozsdamentes acél imitáció	furattávolság C (mm)	
192365	192369	192	214
192366	192370	256	278
192367	192371	320	345
192368	192372	448	470

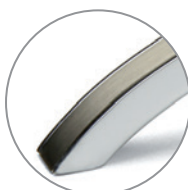
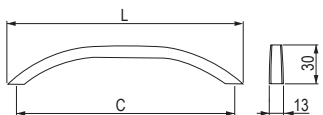

Bari

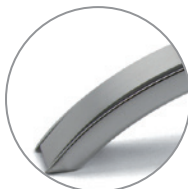
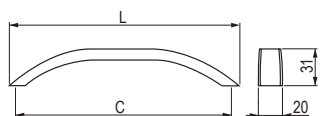

				L hossz (mm)
króm fényes/ rozsdamentes acél imitáció	króm fényes/ króm csiszolt	króm fényes/ fehér matt	furattávolság C (mm)	
192330	192336	192333	192	205
192331	192337	192334	320	334
192332	192338	192335	480	494

Cristina



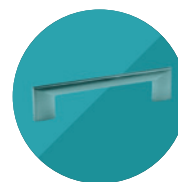

				L hossz (mm)
króm fényes/ rozsdamentes acél imitáció	króm fényes/ króm csiszolt	króm fényes/ fehér matt	furattávolság C (mm)	
192339	192343	192347	192	206
192340	192344	192348	320	334
192341	192345	192349	480	494
192342	192346	×	672	686



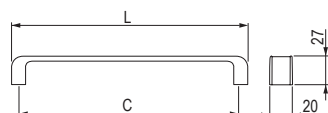
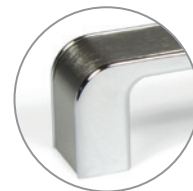



Peca

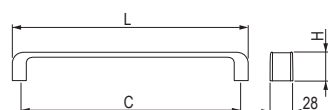

				
króm fényes/ rozsdamentes acél imitáció	króm fényes/ eloxált alumínium	króm fényes/ fehér matt	furattávolság C (mm)	L hossz (mm)
225070	225067	227260	128	142
225071	225068	227261	192	206
225072	225069	225066	256	270



Taca

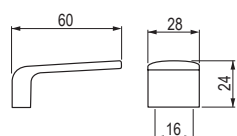

					
króm fényes/ rozsdamentes acél imitáció	króm fényes/ eloxált alumínium	króm fényes/ fehér matt	furattávolság C (mm)	L hossz (mm)	magasság H (mm)
246020	246016	246012	160	176	28
246021	246017	246013	256	272	30
246022	246018	246014	384	400	32

Taca



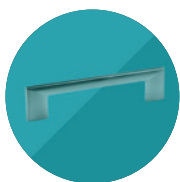

		
króm fényes/ rozsdamentes acél imitáció	króm fényes/ eloxált alumínium	króm fényes/ fehér matt
246019	246015	246011



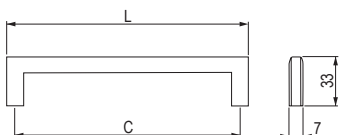

Cubic

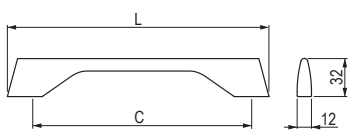
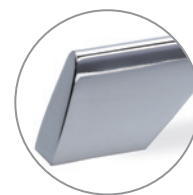

			furattávolság C (mm)	L hossz (mm)
fehér fényes	fekete matt	rozsdamentes acél imitáció		
×	×	157571	128	148
157575	157576	157572	160	180
×	×	157573	192	212
×	×	157574	224	244

Tarana



	furattávolság C (mm)	L hossz (mm)
króm fényes		
284215	192	223
284216	320	351
284217	448	479

Acara

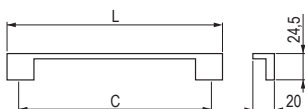

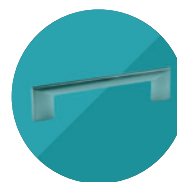

	furattávolság C (mm)	L hossz (mm)
rozsdamentes acél imitáció		
227217	160	168
227218	224	232
227219	320	328
227220	448	456
227221	544	552
227222	640	648



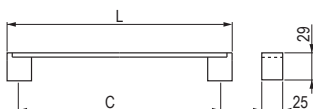

Kofu

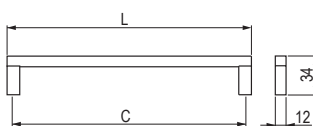

 króm matt/eloxált alumínium	 nikkel csiszolt	furattávolság C (mm)	L hossz (mm)
37850	37860	128	170
37851	37861	160	202
37852	37862	192	234
37853	37863	256	298
37854	37864	320	362
37855	37865	384	426
37856	37866	480	522
37857	37867	544	586
37858	37868	672	714
37859	37869	736	778

Ena



 eloxált alumínium	 rozsdamentes acél imitáció	furattávolság C (mm)	L hossz (mm)
36910	36920	128	140
36911	36921	160	172
36912	36922	224	236
36913	36923	320	332

Penka

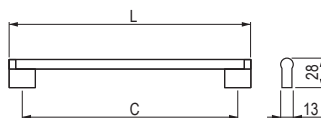
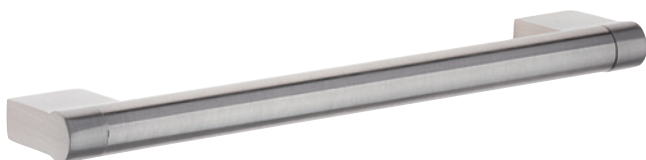

 nikkel csiszolt	furattávolság C (mm)	L hossz (mm)
157249	96	104
157250	128	136
157251	160	168
157252	192	200
157253	224	232
157254	256	264
157255	320	328
157256	448	456
157257	560	568

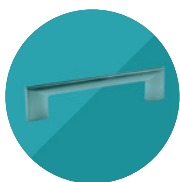

Hrazda

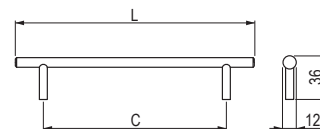
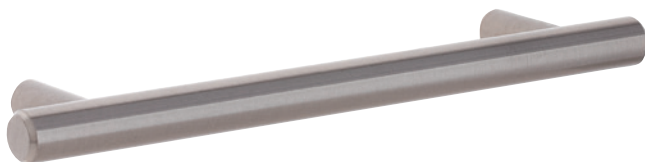

						furattávolság C (mm)	L hossz (mm)
35941	35942	35943	35947	202798	10640	96	136
35921	35922	35923	35927	202799	10641	128	168
35661	35662	35663	35667	202800	10642	160	200
36731	36732	36733	36737	202801	10643	192	232
35931	35932	35933	35937	202802	10644	224	264
36741	36742	36743	36747	202803	10645	288	328
35651	35652	35653	35657	202804	10646	320	360
x	x	x	x	x	10647	384	426
35951	35952	35953	35957	202805	10648	448	488
x	x	x	x	x	10649	512	554
35641	35642	35643	35647	202806	x	544	584
x	x	x	x	x	10650	576	618
x	x	x	x	x	10651	640	682
36751	36752	36753	36757	202807	10652	672	712
35961	35962	35963	35967	202808	10653	736	776
36761	36762	36763	36767	x	10654	768	808
36771	36772	36773	36777	x	10655	832	872
36781	36782	36783	36787	x	x	960	1000

N Hrazda

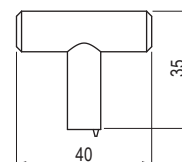

402377	402378	402379	402380	402381

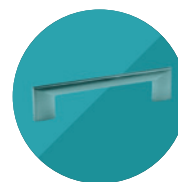

Porta



				furattávolság C (mm)	L hossz (mm)
371989	37909	179439	157786	96	108
371990	37880	37980	157787	128	140
371991	37881	37981	157788	160	172
371992	37882	37982	157789	192	204
371993	37883	37983	157790	224	236
371994	37884	37984	157791	256	268
371995	37885	37985	157792	288	300
371996	37886	37986	157793	320	332
371997	37887	37987	157794	384	396
371998	37888	179441	157795	432	444
371999	37889	37989	157796	448	460
372000	37890	37990	157797	480	492
372001	37891	37991	157798	544	556
389791	37893	37993	157800	672	684
389789	37894	37994	157801	736	748
389791	37895	37995	157802	768	780
389792	x	x	x	832	844
389793	x	x	x	864	876
389794	x	x	x	960	972

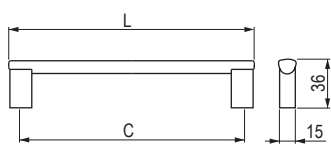

Lila



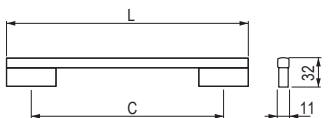

			furattávolság C (mm)	L hossz (mm)
284109	284117	284125	96	146
284110	284118	284126	128	177
284111	284119	284127	160	226
284112	284120	284128	192	258
284113	284121	284129	224	290
284114	284122	284130	320	386
284115	284123	284131	480	546
284960	284962	284964	544	604
284116	284124	284132	672	738

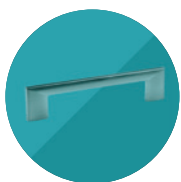



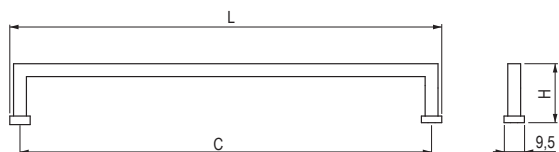

N Bastone



 króm fényes	 fekete matt	furattávolság C (mm)	L hossz (mm)	magasság H (mm)
402388	402389	128	138	34
402391	402392	160	170	34
402453	402393	192	201,5	34
402394	402395	320	330	28

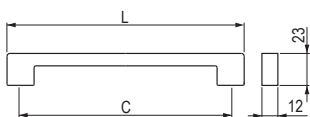

Nagisa



	furattávolság C (mm)	L hossz (mm)
77912	96	115
77913	128	147
77914	160	179

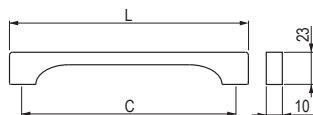

Tenga

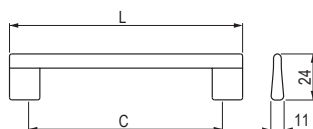

	 rozsdamentes acél imitáció	furattávolság C (mm)	L hossz (mm)
77950	77951	160	179
77952	77953	320	344

Foka



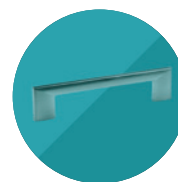

	 rozsdamentes acél imitáció	furattávolság C (mm)	L hossz (mm)
77954	77955	160	189
77956	77957	320	349



Daive



		furattávolság C (mm)	L hossz (mm)	D szélesség (mm)	H magasság (mm)
343940	343951	96	104	8	28
343941	343952	128	136	8	28
343942	343953	160	168	8	28
343943	343954	192	200	8	28
343944	343955	224	232	8	28
343945	343957	320	328	8	28
343946	343958	448	456	8	28

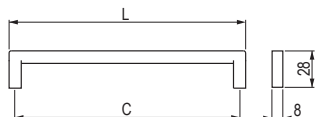

Marina



	furattávolság C (mm)	L hossz (mm)
203829	128	138
203822	160	170
203823	192	202
203824	224	234
203825	320	330
203826	480	490
203827	640	650
203828	736	746

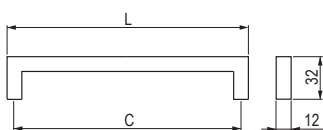

Sakata



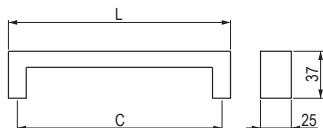

	furattávolság C (mm)	L hossz (mm)
157547	160	172
157548	192	204
157549	256	268
157550	320	332

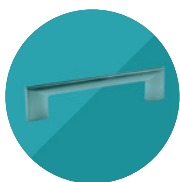

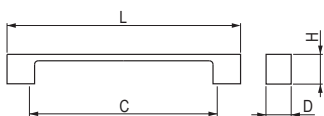

Sosa



 króm matt	 nikkel csiszolt	furattávolság C (mm)	L hossz (mm)	D szélesség (mm)	H magasság (mm)
37031	37032	160	190	20	24
37033	37034	192	225	25	26

Lacata

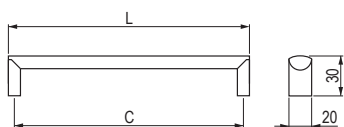

 rozsdamentes acél imitáció	 eloxált alumínium	furattávolság C (mm)	L hossz (mm)
227223	227230	128	138
227224	227231	160	170
227225	227232	224	234
227226	227233	320	330
227227	227234	448	458
227228	×	544	554
227229	×	640	650

Kamota

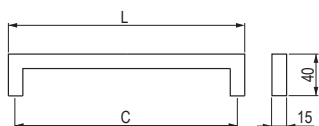

 csiszolt nemesacél	furattávolság C (mm)	L hossz (mm)
157717	160	175
157718	192	207
157719	256	271
157720	320	335

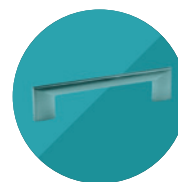

Menusa





eloxált alumínium

35971

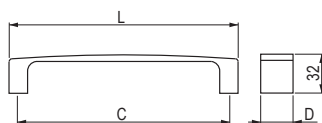
Towada



		furattávolság C (mm)	L hossz (mm)	D szélesség (mm)	H magasság (mm)
157193	157196	128	143	25	22
157194	157197	160	175	22	32
157195	157198	224	239	22	32

Carina

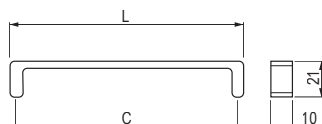

		furattávolság C (mm)	L hossz (mm)
192363	192364	128	135

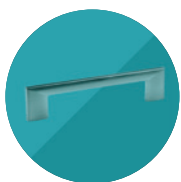

Josa

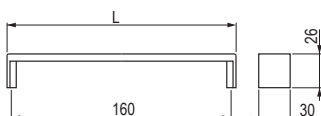
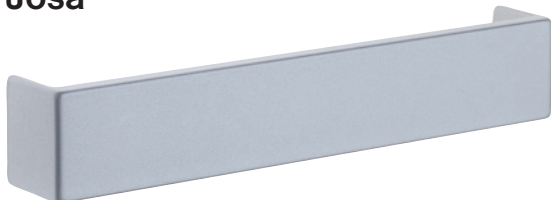

króm matt

77910

Raka

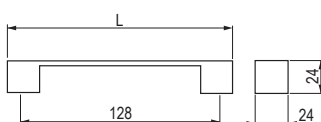
sötét nikkél
csiszolt**267243**

Ulica

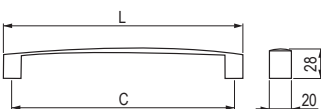
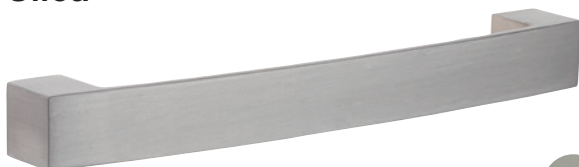

nikkel matt



nikkel csiszolt



króm fényes

rozsdamentes
acél imitáció

króm matt

					furattávolság C (mm)	L hossz (mm)
303323	355912	303317	289690	289696	128	146
303324	355913	303318	289691	289697	160	178
303325	355914	303319	289692	289698	192	210
303326	355915	303320	289693	289699	256	274
303327	355916	303321	289694	289700	320	338
303328	355917	303322	289695	289701	416	434

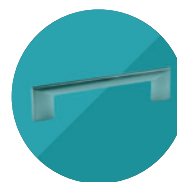

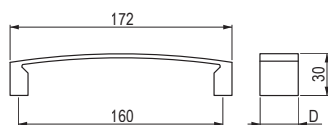

Argus X



		D szélesség (mm)
króm matt	rozsdamentes acél imitáció	
42075	42076	25



N Sempli

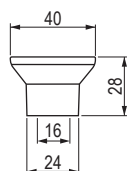

	
fekete matt	szürke matt
399524	399525

N Sempli



	
fekete matt	szürke matt
399527	399528

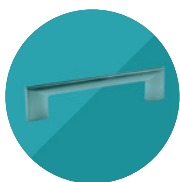

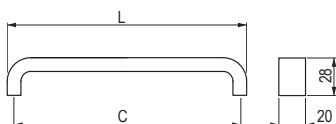

Recife



 rozsdamentes acél imitáció	furattávolság C (mm)	L hossz (mm)
157638	128	137
157639	192	201
157640	224	233
157641	256	265
157642	320	329
157643	448	457

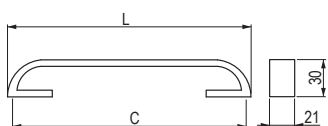
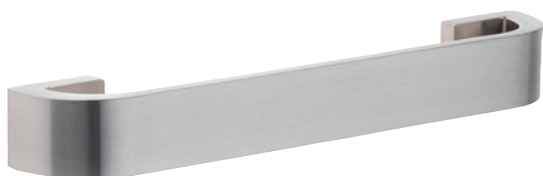

Beluga

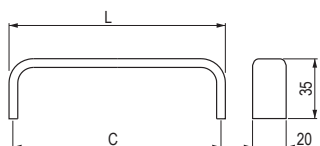

 rozsdamentes acél imitáció	furattávolság C (mm)	L hossz (mm)
42051	128	137
42053	160	169
42055	224	233

Muta



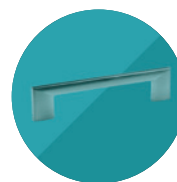

 eloxált alumínium	 rozsdamentes acél imitáció	furattávolság C (mm)	L hossz (mm)
36821	36829	128	136
36822	36830	160	168
36823	36831	192	200
36824	36832	224	232
36825	36833	320	328
36826	36834	448	456
36827	×	544	552



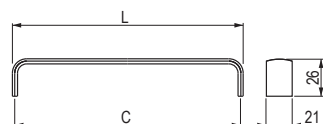

Oga



			L
króm matt	nikkel csiszolt	furattávolság C (mm)	hossz (mm)
157203	157199	96	102
157204	157200	128	134
157205	157201	160	166
157206	157202	192	198

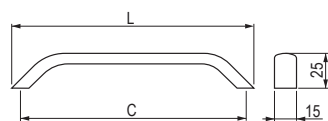

Marca

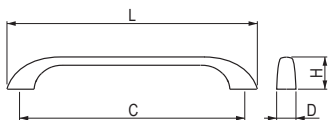

		L
rozsdamentes acél imitáció	furattávolság C (mm)	hossz (mm)
225008	160	197
225009	192	229
225010	224	261
225011	320	357
225012	448	485

Asama



				L	D	H
króm matt	nikkel csiszolt	nikkel matt	furattávolság C (mm)	hossz (mm)	szélesség (mm)	magasság (mm)
157231	157234	157228	160	204	17	26
157232	157235	157229	192	245	18	29
157233	157236	157230	288	366	20	31

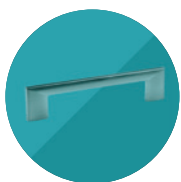

Alma

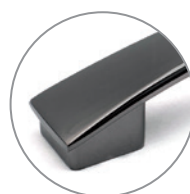
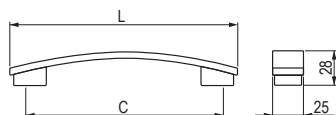

● sötét nikkelfényes	furattávolság C (mm)	L hossz (mm)
340588	160	183
340589	320	340

Scala

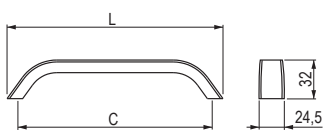

● barna matt	● eloxált aluminium	● rozsdamentes acél imitáció	● csiszolt fekete	furattávolság C (mm)	L hossz (mm)
×	227248	227239	×	128	147
261978	227249	227240	378651	160	179
261979	227250	227242	378652	192	211
261980	227251	227243	378653	224	243
261981	227252	227244	378654	320	339
×	227253	227245	378655	448	467
×	227254	227246	378656	544	563
×	227255	227247	378657	640	659



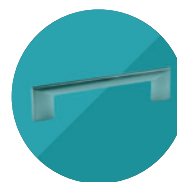

Francesca

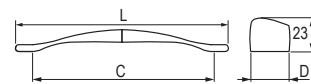

					furattávolság C (mm)	L hossz (mm)	D szélesség (mm)
króm fényes	nikkel csiszolt	rozsdamentes acél imitáció	nikkel sötét fényes	nikkel sötét matt	160	185	22,5
284994	284995	284996	284997	284998	320	339	23,5
284999	285000	285001	285002	285003			

 Graffito

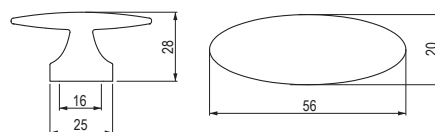

	
ófekete csiszolt	sötét nikkel fényes
398278	398242

Sema

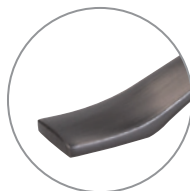
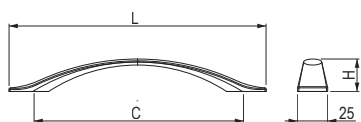

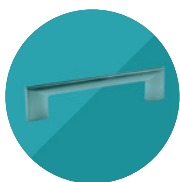

	furattávolság C (mm)	L hossz (mm)	H magasság (mm)
sötét nikkel csiszolt			
284053	128	181	27
284054	160	214	27
284055	256	309	29
284056	320	374	29



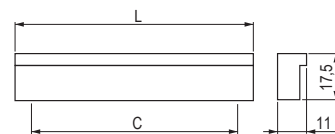
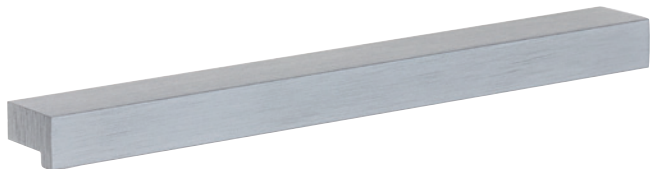



Hytech

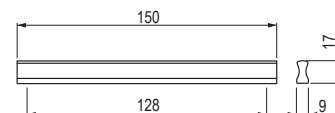

 eloxált alumínium	 rozsdamentes acél imitáció	furattávolság C (mm)	L hossz (mm)
190523	359394	64	90
359390	359396	96	120
359392	359397	128	150

Jakoto



 rozsdamentes acél imitáció	 króm matt	 eloxált alumínium
361877	37051	37053

Likano

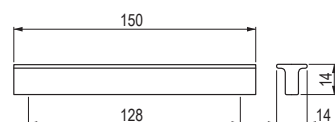

eloxált alumínium
36332

Wakano

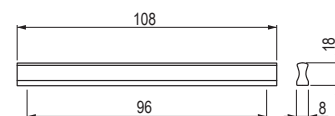

eloxált alumínium
36333



Taloma

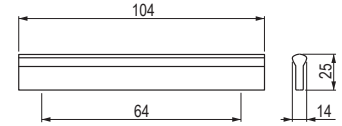
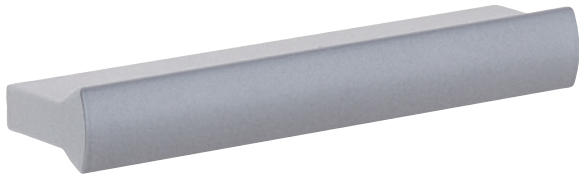

eloxált alumínium
37004

Zuzana

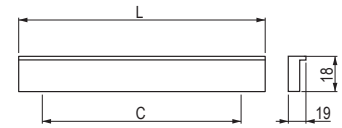

eloxált alumínium	furattávolság C (mm)	L hossz (mm)
35900	32	44
35898	128	140

Petaro

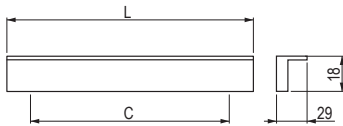

eloxált alumínium	furattávolság C (mm)	L hossz (mm)
157519	96	108
36320	128	140
36321	160	172
36322	224	236
36323	360	372
36324	448	460

Isola

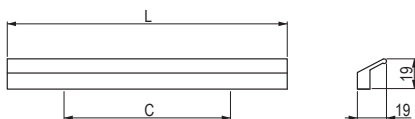

króm fényes	rozsdamentes acél imitáció	eloxált alumínium	furattávolság C (mm)	L hossz (mm)
227293	227297	227301	96	116
227294	227298	227302	160	180
227295	227299	227303	224	244
227296	227300	227304	320	340

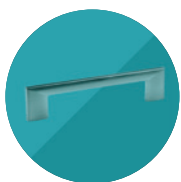

Inclina

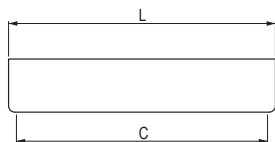
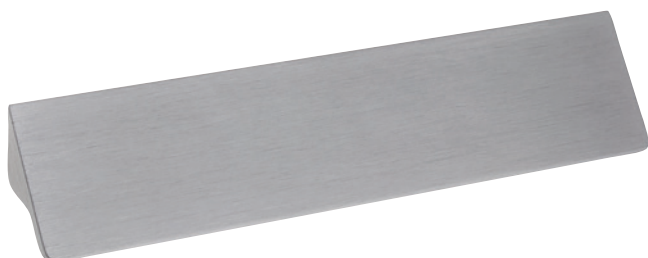

 rozsdamentes acél imitáció	furattávolság C (mm)	L hossz (mm)
225062	96	116
225063	160	180
225064	224	244
225065	320	340



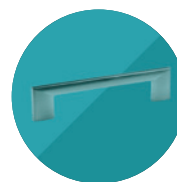

Patric

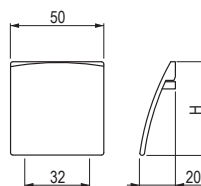

króm matt	H magasság (mm)
77923	28
77924	50

Zito

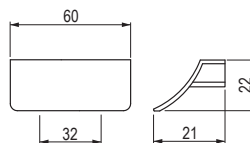

króm matt
77925

Ketina

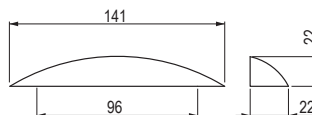

króm matt
35872

Merita

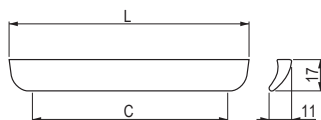

króm matt	rozsdamentes acél imitáció	furattávolság C (mm)	L hossz (mm)
77946	77947	160	178
77948	77949	256	338

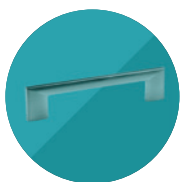

Kvadra

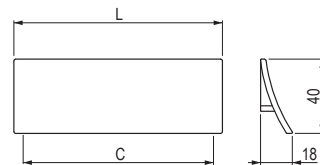
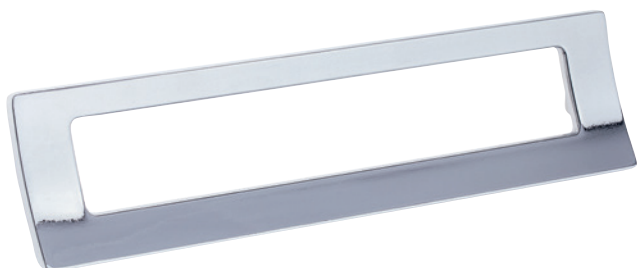

 króm fényes	furattávolság C (mm)	L hossz (mm)
77962	32	48
77960	160	175
77964	320	335

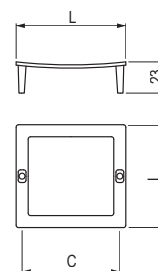

Frame

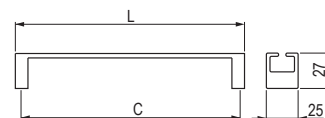
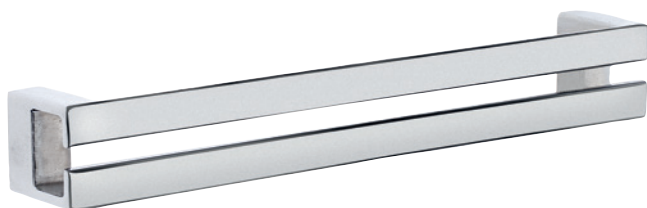

 rozsdamentes acél imitáció	 fekete matt	furattávolság C (mm)	L hossz (mm)
42096	396168	32	41

Omono



 króm fényes	 nikkelt csiszolt	furattávolság C (mm)	L hossz (mm)
157187	157188	128	137
157185	157186	160	169
226972	226973	320	328

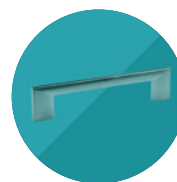

Fiona

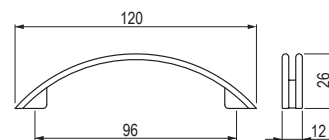
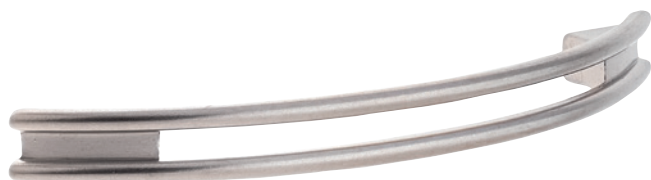

nikkel matt	króm matt	króm fényes
35041	35042	35043

Paura

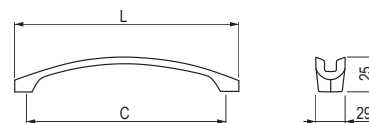

	furattávolság C (mm)	L hossz (mm)
351886	160	180
351887	320	340

Elipse

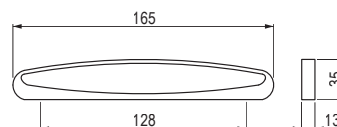

rozsdamentes acél imitáció
42002

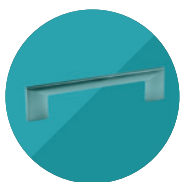

Rodoso

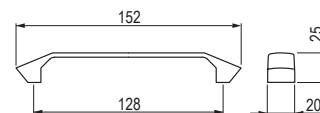

króm matt

37761

Kamina

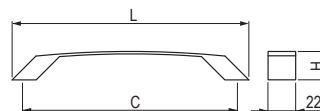

króm matt

77936rozsdamentes
acél imitáció**77939**furattávolság
C (mm)L
hossz
(mm)H
magasság
(mm)

160

191

26

77937**77940**

256

287

27

Pamil

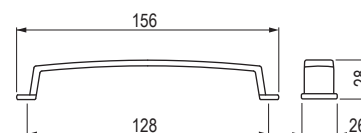

króm matt

35822

nikkel csiszolt

35827

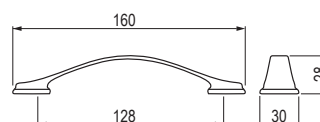

Mariba

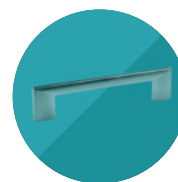
rozsdamentes
acél imitáció**267104**sötét nikkelt
csiszolt**267105**

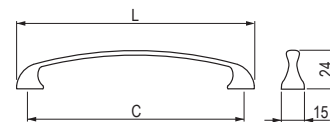

Uroso



 nikkelt matt	 króm matt	 króm fényes	furattávolság C (mm)	L hossz (mm)
35631	35632	35633	96	112
35141	35142	x	128	146

Palin

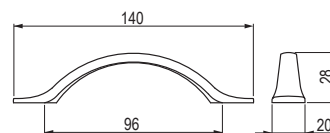

 szatén nikkelt
35561

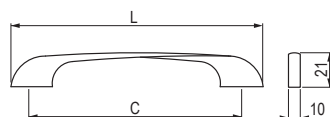

Besina

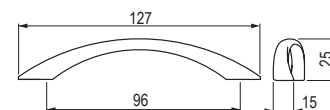

 nikkelt matt	furattávolság C (mm)	L hossz (mm)
35471	96	121
35481	128	157
35491	160	190

Halena



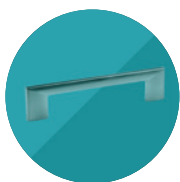

 nikkelt matt	 króm matt	 króm fényes
35291	35292	35293

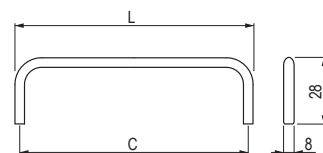

Ida



			furattávolság C (mm)	L hossz (mm)
35341	157542	157543	96	104
157544	157545	157546	128	136
231423	231424	231422	160	170

Dalo

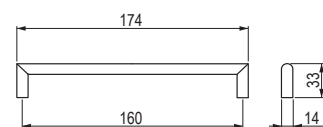

szatén króm

36312

Aira

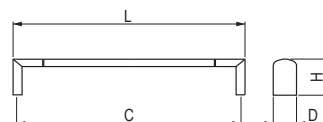

	furattávolság C (mm)	L hossz (mm)	D szélesség (mm)	H magasság (mm)
37301	96	105	17	28
37302	128	137	17	28
37311	128	140	24	32
37312	160	172	24	32
37313	320	332	24	32

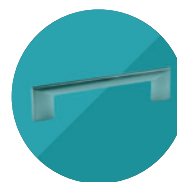

Dara

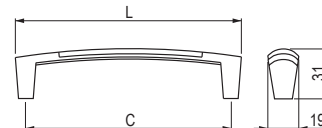

króm matt/
króm fényes

37751

Musina

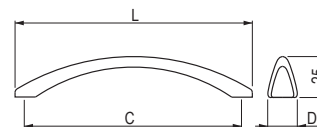

króm matt/
króm fényes

	furattávolság C (mm)	L hossz (mm)	D szélesség (mm)
37101	64	82	13
37102	96	123	18

Sita

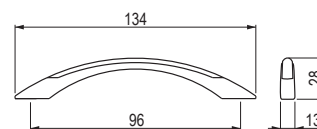

króm matt/
króm fényes

37131

Rusa

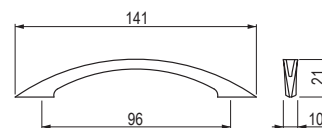

króm matt/
króm fényes

37111

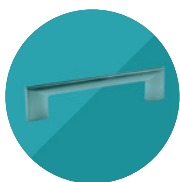

Ibika

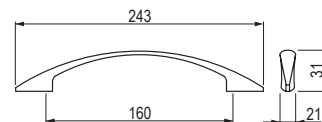

nikkel matt

35701

Nomina

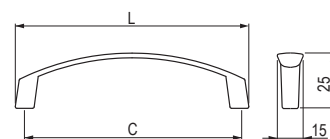

króm matt

157534**35232**

nikkel matt

157535**35231**furattávolság
C (mm)

96

128

L

hossz
(mm)

108

140

Iluna

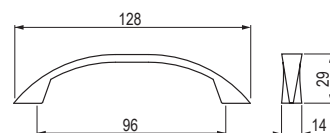

króm matt

157527

nikkel csiszolt

157528

nikkel matt

35301

Peneta

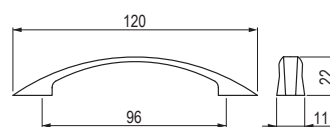

nikkel matt

289686

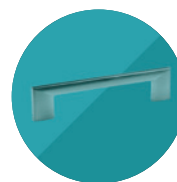

Ruona

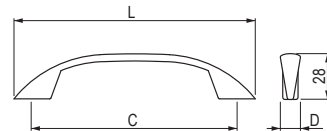

					furattávolság C (mm)	L hossz (mm)	D szélesség (mm)
35451	35452	35453	35454	35455	96	132	15
35461	35462	35463	x	x	128	164	16

Kewina

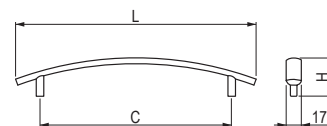
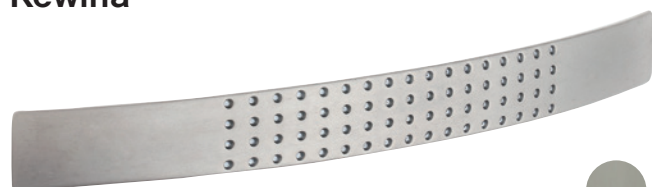

			furattávolság C (mm)	L hossz (mm)	H magasság (mm)
35161	35162	35163	96	124	25
35151	35152	35153	128	156	27

Marusa

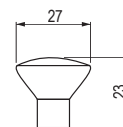

35171	35172	35173

Ruda

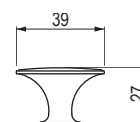

35892

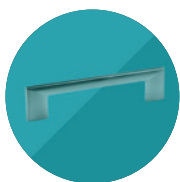

Beta

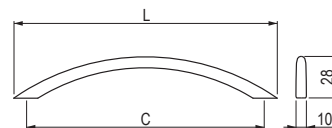

							furattávolság C (mm)	L hossz (mm)
nikkel matt	króm matt	króm fényes	arany fényes	fekete matt	fehér fényes	nikkel csiszolt	96	110
35011	35012	35013	35014	35015	35019	35017	128	160
35021	35022	35023	×	35025	157522	157523		

Rotonda

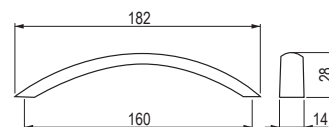

rozsdamentes acél imitáció	fehér matt
227259	227258

Piombina

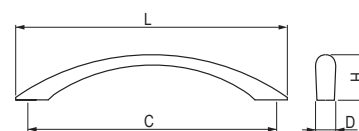

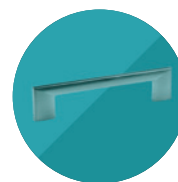

								furattá- volság C (mm)	L hossz (mm)	D szé- lesség (mm)	H magas- ság (mm)
nikkel matt	króm matt	króm fényes	arany fényes	fekete matt	nikkel sötét fényes	nikkel csiszolt	óréz sötét	96	127	12	24
35251	35252	35253	35254	35255	35258	157520	226980	128	164	14	28
35241	35242	×	×	35245	×	157521	226981				

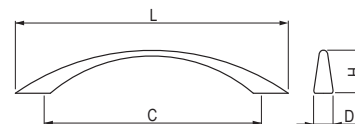

Anita



									furattávolság C (mm)	L hossz (mm)	D szélesség (mm)	H magasság (mm)
35071	35072	35073	35074	35075	×	×	×	×	64	81	9	23
35081	35082	35083	35084	35085	35089	35088	157525	226985	96	115	10	28
35091	35092	35093	35094	35095	×	35098	157526	226987	128	164	11	28

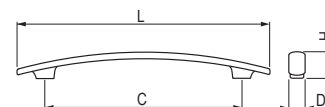

Timina

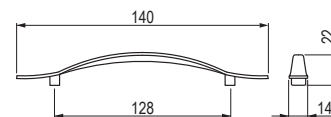

	furattávolság C (mm)	L hossz (mm)	D szélesség (mm)	H magasság (mm)
157715	160	190	10	25

Luda



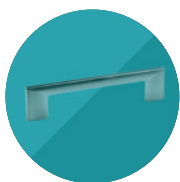

		
289666	289667	289668



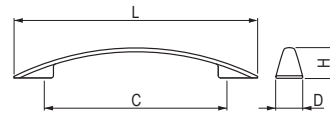

Unesa

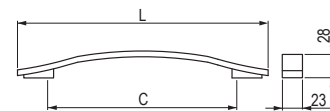

		furattávolság C (mm)	L hossz (mm)	D szélesség (mm)	H magasság (mm)
157529	157530	96	141	16	23
35412	157531	128	186	21	24
157532	157533	160	216	21	24

Selena



		furattávolság C (mm)	L hossz (mm)
77942	77943	160	216
77944	77945	256	341

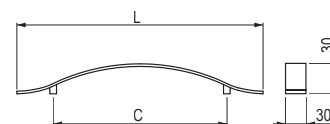

Cordoba

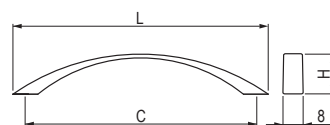

	furattávolság C (mm)	L hossz (mm)
157609	160	257
157610	192	289

Sakita



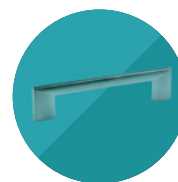

			furattávolság C (mm)	L hossz (mm)	H magasság (mm)
157556	157554	157555	96	116	25
157723	157721	157722	128	150	31



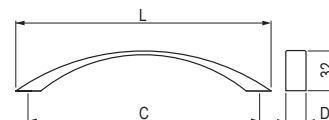

Pelena

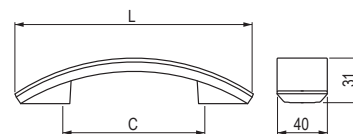

 króm matt	 nikkel csiszolt	furattávolság C (mm)	L hossz (mm)	D szélesség (mm)
157832	157824	96	106	18
157833	157825	128	140	19
157834	157826	160	174	20
37742	37741	192	228	20
157835	157827	224	257	20

Padova



 rozsdamentes acél imitáció	furattávolság C (mm)	L hossz (mm)
157617	96	162
157618	224	290

Geneda

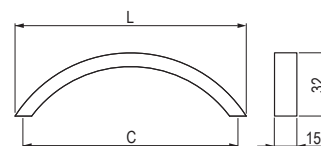

 króm matt	 nikkel csiszolt	furattávolság C (mm)	L hossz (mm)
35112	157537	96	108
157539	157540	128	140



Vereca

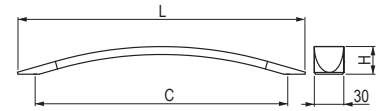

 rozsdamentes acél imitáció	furattávolság C (mm)	L hossz (mm)	H magasság (mm)
284100	160	190	28
284101	224	266	28
284102	320	356	32,6
284103	480	550	32,6

Malada

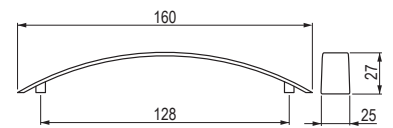

króm matt

35832

nikkel csiszolt

35837

Dora

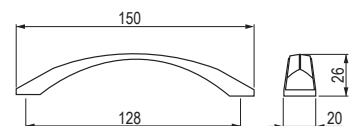

ócink csiszolt

226968

öréz sötét

226970

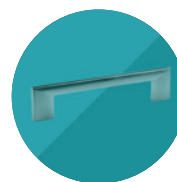

Enza

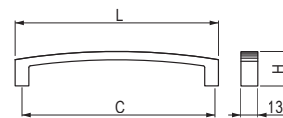

króm fényes	furattávolság C (mm)	L hossz (mm)	H magasság (mm)
US004	96	107	22
US001	128	140	25

Enza

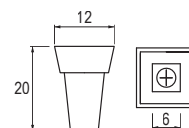

króm fényes
US003

Ruota

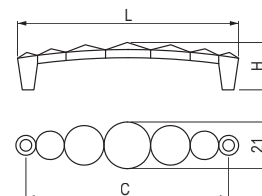

ROUTA bútorgomb
(old. 4.63)

króm fényes	furattávolság C (mm)	L hossz (mm)
US008	32	48
US007	96	114
US006	128	145

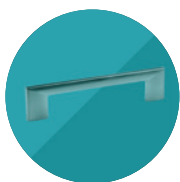

Ruota

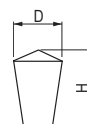
ROUTA fogantyú
(old. 4.62)

króm fényes	szélesség D (mm)	magasság H (mm)
US011	15	21

Kutta

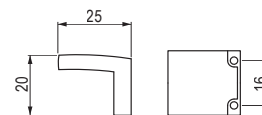

króm fényes

US005

Kutta

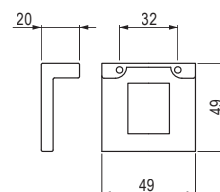

króm fényes

US002

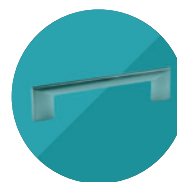

Lokuta

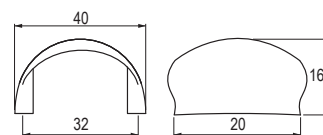

króm matt

37172



nikkel matt

07756

Iroko

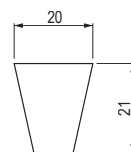
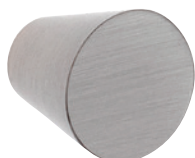

króm matt

37251



nikkel csiszolt

37252

N Koby

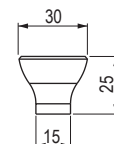

fekete matt

401559



barna matt

401560



eloxált alumínium

401561

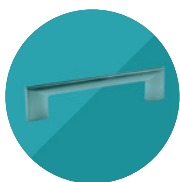

N Evan

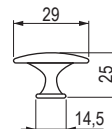

fekete matt	nikkel matt	króm matt	króm fényes	fekete fényes
401570	401571	401572	401573	401574

Ruza

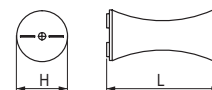

					D szélesség (mm)	H magasság (mm)
nikkel matt	króm matt	króm fényes	nikkel csiszolt	fekete matt		
157289	157290	157292	157291	157293	16	27
157294	157295	157297	157296	157299	21	35

Jota

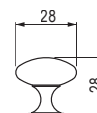

fehér fényes	nikkel matt	króm matt	króm fényes	arany fényes	fekete matt	nikkel csiszolt
401575	35001	35002	35003	35004	35005	35007

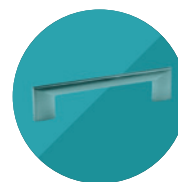

Galka

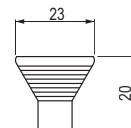

króm fényes

289671



króm matt

289672

Nodie

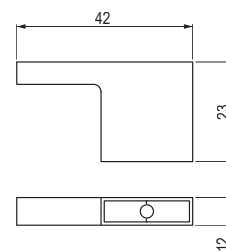
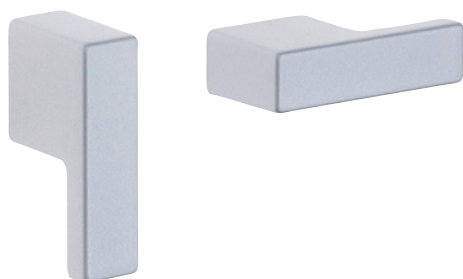

króm matt

77916

Tucana

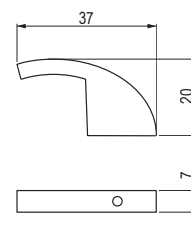
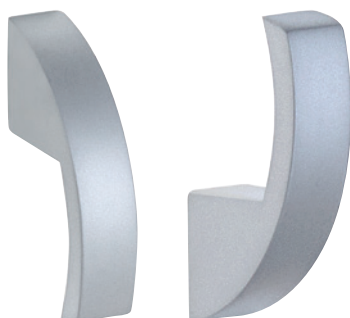

króm matt

37162

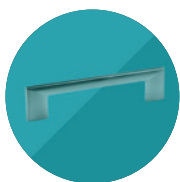

Luna



rozsdamentes
acél imitáció

42004

Whale

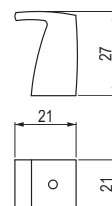

króm matt

42029



rozsdamentes
acél imitáció

42030

Ota

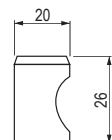

csiszolt
nemesacél

202884

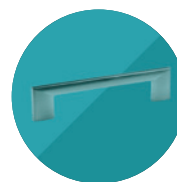

Zola



króm matt

37181

Tinto

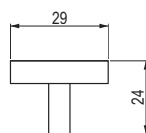

króm matt

36313



króm fényes

36314

Collet

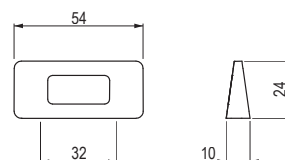

ófekete

351878

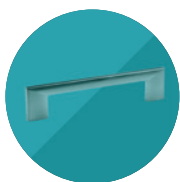

Prisma

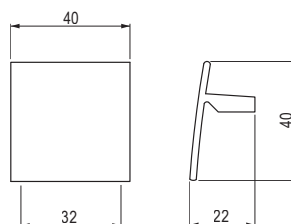

króm matt

42016rozsdamentes
acél imitáció**42017**

Vintage O

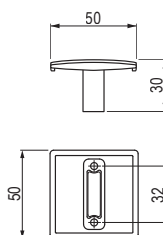

króm matt

157649rozsdamentes
acél imitáció**157651**

fekete matt

157653

Vintage ST

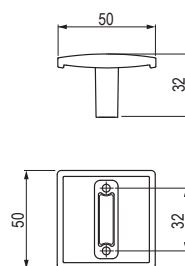

óbronz

42084



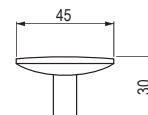

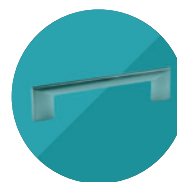
Vintage R

rozsdamentes
acél imitáció**157646**

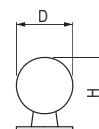





Tomic

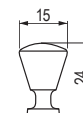

				D szélesség (mm)	H magasság (mm)
nikkel matt	króm matt	króm fényes	arany fényes	18	23
35261	35262	35263	×	25	32
35271	35272	35273	35274		



Ukuda



			
nikkel matt	króm matt	króm fényes	csiszolt nikkel
157305	157306	157308	157307

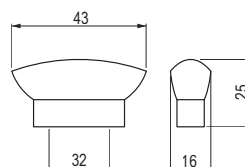

Mateo

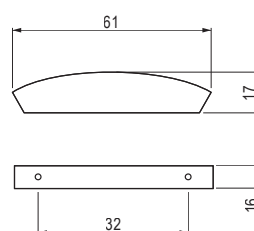

	
nikkel matt	króm matt
35521	35522

Setan



	
króm matt	nikkel csiszolt
157238	157240



FOGANTYÚK ÉS FOGASOK

rusztikus és porcelán fogantyúk és bútorgombok

TULIP

Tulip rusztikus
és porcelán
fogantyúk és bútorgombok





Virella S

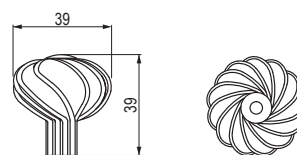

ócinke

157279

Virella M

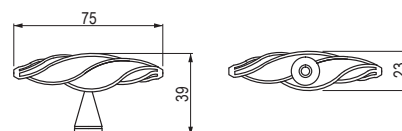

ócinke

157280

Virella L

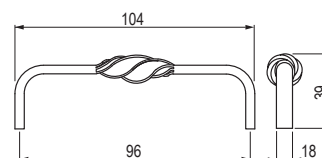

ócinke

157281



Tomo

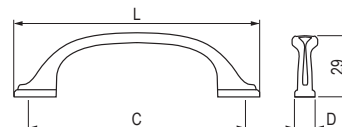

 ócink csiszolt	 óréz sötét	furattávolság C (mm)	L hossz (mm)	szélesség D (mm)
226919	226920	96	132	14
226921	226922	160	204	16

Tomo

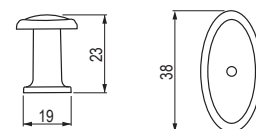

 ócink csiszolt	 óréz sötét
226917	226918

Rustik

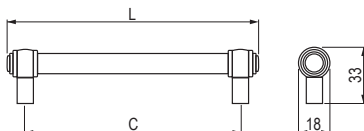

 óarany	 ócink csiszolt	furattávolság C (mm)	L hossz (mm)
296149	296156	128	149
296150	296157	160	181
296151	296158	192	213
296152	296159	224	245
296153	296160	256	277
296154	296161	320	341
296155	296162	448	469

Rustik

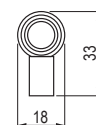

 óarany	 ócink csiszolt
296164	296165



Locarno

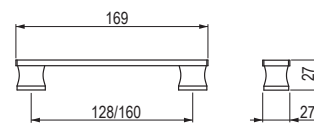

óarany

284322



ócink
csiszolt

284323

Locarno

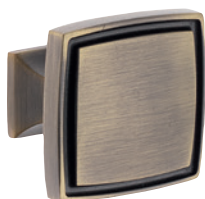

fogas
(old. 4.141)

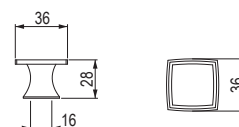

óarany

284319



ócink
csiszolt

284320

N Menfi

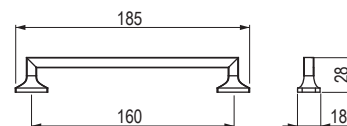

fekete matt

400314

N Menfi

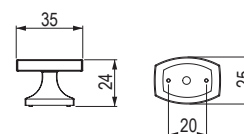



fekete matt

400316

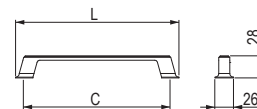

Curu



	furattávolság C (mm)	L hossz (mm)
284222	128	158
284223	192	222

Curu

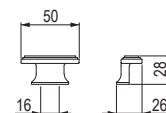

óbronz

284221

Tuvola

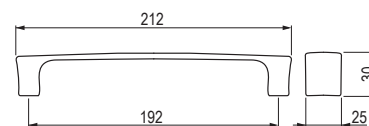

ócink

267109

Tuvola

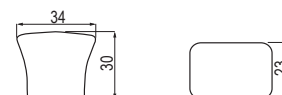

ócink

267122



Serena

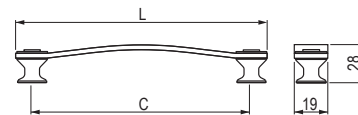

óarany	furattávolság C (mm)	L hossz (mm)
157282	96	115
157283	128	147
157284	160	180

Serena

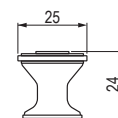

óarany
157285

Sekol

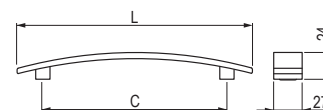

óarany	furattávolság C (mm)	L hossz (mm)
157270	96	156
157271	128	188
157272	160	230

Sekol

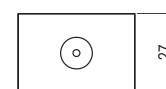
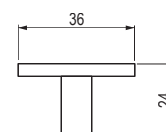

óarany
157267



Stockholm

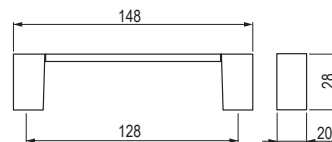
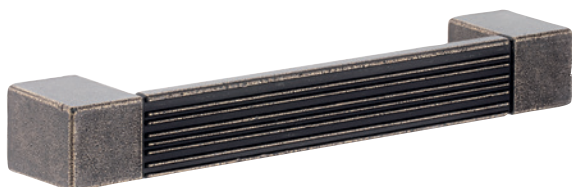

óbronz
157663



ócink
157664

Stockholm

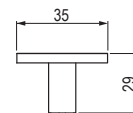

óbronz
157660



ócink
157661

Uliko

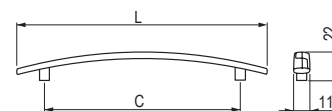

óarany
157265

furattávolság
C (mm)

L
hossz
(mm)

157266

96

141

157266

128

173

Turia

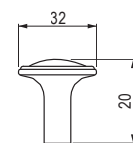

nikkel matt
157300



króm matt
157301



nikkel csiszolt
157302



króm fényes
157303





óarany
157304

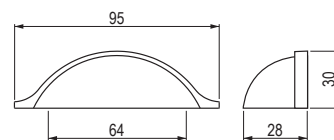

Corsica



	
ófekete	ócink
202869	202871



Cona

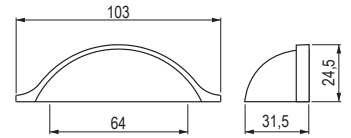

óarany

285004

ófekete

351875

Toronto

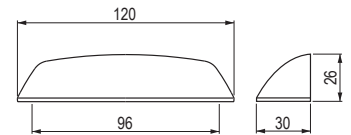

ófekete

202847

ócink

202849

Shell

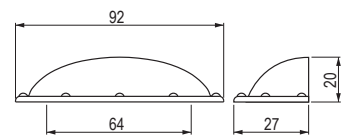

ófekete

202872

ócink

202874

Stamp

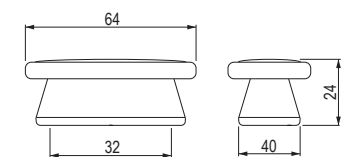

ófekete

204107



ócink

204109



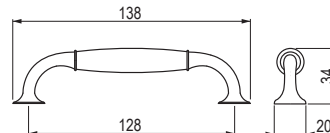

Victoria

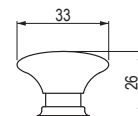

	
ófekete	óbronz
42103	157685

Victoria



	
ófekete	óbronz
42104	157684

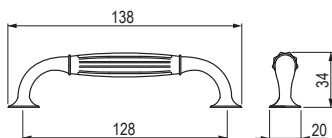
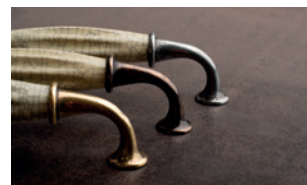

Country

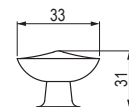
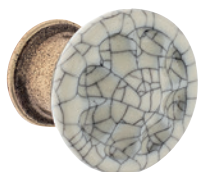

		
óarany/ porcelán bézs	óbronz/ porcelán bézs	ófekete/ porcelán bézs
157681	42100	157678

Country



		
óbronz/ porcelán bézs	ófekete/ porcelán bézs	óarany/ porcelán bézs
42102	157676	157679



FOGANTYÚK ÉS FOGASOK

rusztikus és porcelán fogantyúk és bútorgombok

TULIP





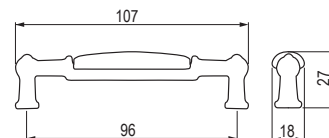

Sara

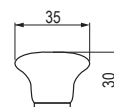

	
ócsink / fehér porcelán	óarany/ fehér porcelán
288823	288824

Stela



	
ócsink / fehér porcelán	óarany/ porcelán bézs
288820	288821

Rosa

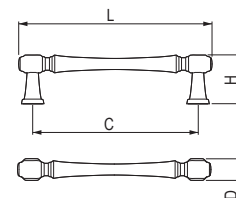

				
arany rozé matt	furattávolság C (mm)	L hossz (mm)	D szélesség (mm)	H magasság (mm)
360606	96	112	13	29
360607	128	144	13	29
360608	160	176	13	29



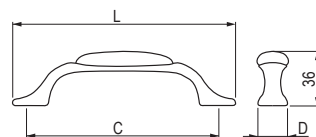

Margarita



 ócink / porcelán / motívum	 ócink / fehér porcelán	furattávolság C (mm)	L hossz (mm)	D szélesség (mm)
288805	288806	96	127	25
288800	288801	128	159	26

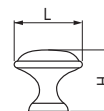

Margarita

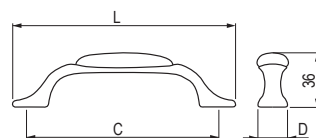

 ócink / porcelán / motívum	 ócink / fehér porcelán	D szélesség (mm)	L hossz (mm)	H magasság (mm)
288810	288811	35	35	27

Margarita





 óarany/ porcelán/motívum	 óarany/ porcelán bézs	furattávolság C (mm)	L hossz (mm)	D szélesség (mm)
288808	288807	96	127	25
288803	288802	128	159	26

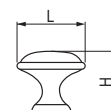

Margarita





 órány/porcelán/ motívum	 órány/ porcelán bézs	L hossz (mm)	D szélesség (mm)	H magasság (mm)
288813	288812	35	35	27





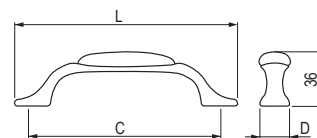

Margarita

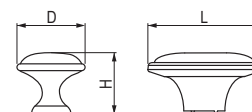

 barna/ porcelán/motívum	furattávolság C (mm)	L hossz (mm)	D szélesség (mm)
288809	96	127	26
288804	128	159	25

Margarita



	 barna/ porcelán/motívum	L hossz (mm)	D szélesség (mm)	H magasság (mm)
○	288814	35	35	27
◌	288819	58	34	25

Vintage

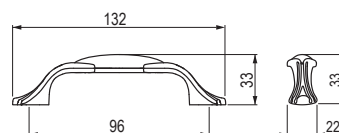

 óarany/ porcelán/motívum
360611



Vintage

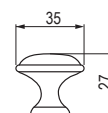

óarany/
porcelán/
motívum

360609

Paris

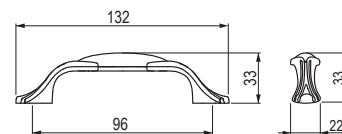

óarany/
porcelán/
motívum

360612

Paris

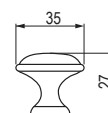

óarany/
porcelán/
motívum

360610

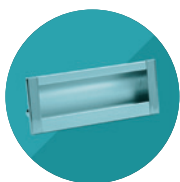

FOGANTYÚK ÉS FOGASOK

süllyesztett fogantyúk és profilok

TULIP

Tulip süllyesztett
fogantyúk
és profilok



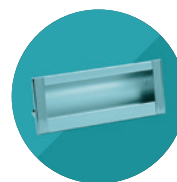

N Misura

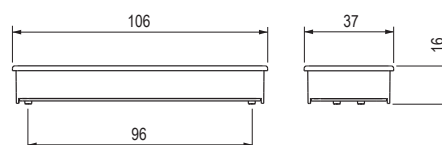

	furattávolság C (mm)	L hossz (mm)
arany matt	96	106
399523		

N Shellby

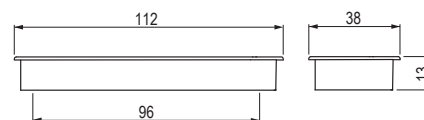

			
nikkel csiszolt	ófekete	óbronz	fekete matt
398092	398093	398094	398095

N Carpi

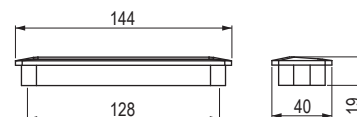

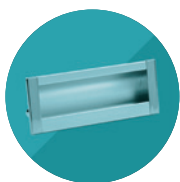

	
antracit	nikkel matt
400311	400312



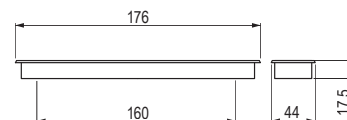



Inside

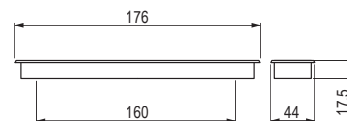

			bemélyedés mérete (bemarás) (mm)
351942	351943	351944	172 × 39 × 14

Gliss



			bemélyedés mérete (bemarás) (mm)
351939	351940	351941	172 × 39 × 14

Elsősorban tolóajtókhoz tervezett modell.

Swift

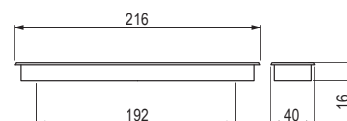



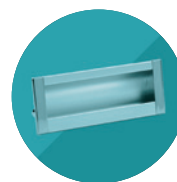

		bemélyedés mérete (bemarás) (mm)
42112	157579	211 × 35 × 14

Elsősorban tolóajtókhoz tervezett modell.

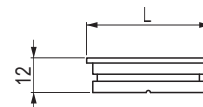

Kaniva



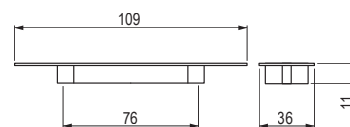

			L hossz (mm)	mélyedés méretei (bemarás) (mm)
35531	35532	35533	40	35 × 35 × 10
35541	35542	35543	50	42 × 42 × 10

Avoca





Elsősorban tolóajtókhoz tervezett modell.

			mélyedés méretei (bemarás) (mm)
37771	37773	15779	82 × 26,5 × 9

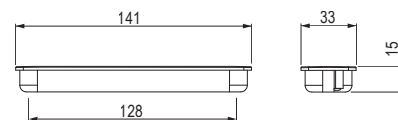
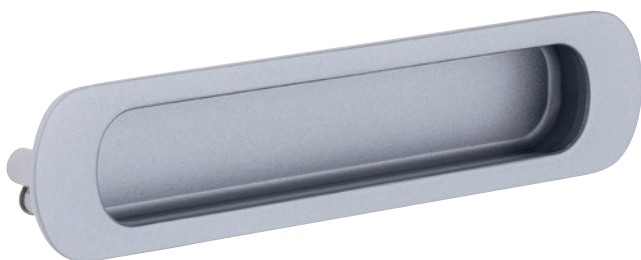
Hana



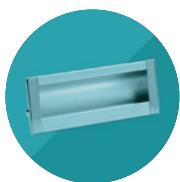

Elsősorban tolóajtókhoz tervezett modell.

	
360475	360476



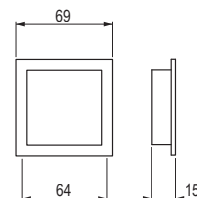

Mane



	bemélyedés mérete (bemarás) (mm)
ezüst	
77823	63,2 × 63,2 × 13

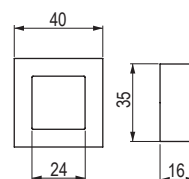

Panel

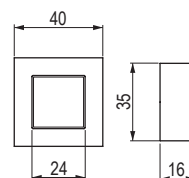
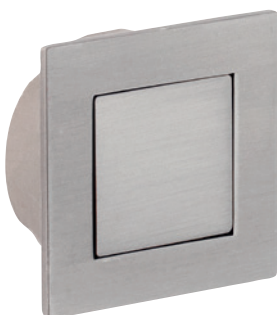

	
nikkel csiszolt	króm fényes
401582	401583

Panel F



	
nikkel csiszolt	króm fényes
401584	401585

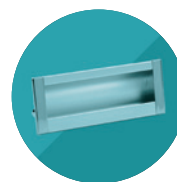

N Ring

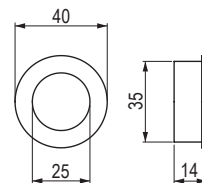

nikkel csiszolt

401586



króm fényes

401587

N Ring F

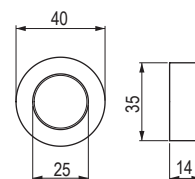

nikkel csiszolt

401588



króm fényes

401589

Utara

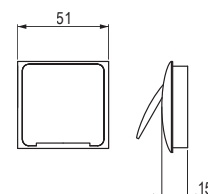

nikkel csiszolt

37261



króm matt

37262

bemélyedés mérete
(bemarás)
(mm)

46 × 46 × 10,2

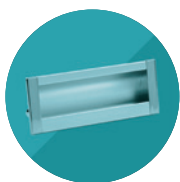

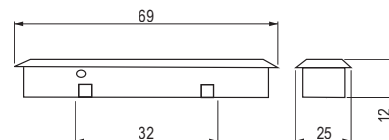

Portos

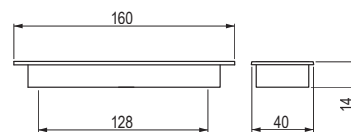

	bemélyedés mérete (bemarás) (mm)
króm matt	
226935	64 × 19 × 10

Madrid





	bemélyedés mérete (bemarás) (mm)
ezüst	
36334	142,6 × 30 × 12

Elsősorban tolóajtókhoz tervezett modell.

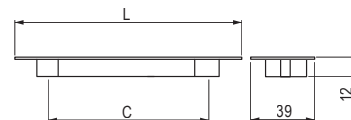
Pesara



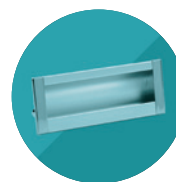

			furattávolság C (mm)	L hossz (mm)	bemélyedés mérete (bemarás) (mm)
157782	157783	157784	96	107	102 × 28 × 10
157781	37781	37783	128	139	135 × 28 × 10



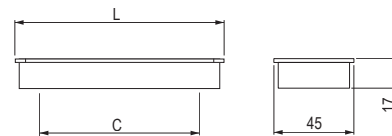

Cesaro



			furattávolság C (mm)	L hossz (mm)	bemélyedés mérete (bemarás) (mm)
króm csiszolt	króm fényes	rozsdamentes acél imitáció			
192355	192356	192357	96	119	114,5 × 40 × 15
192358	192359	192360	160	183	168,5 × 40 × 15
203959	203960	203961	320	343	338,5 × 40 × 15
x	203963	x	480	503	488,5 × 40 × 15

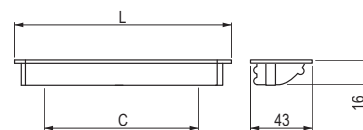

Concava

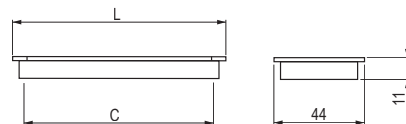
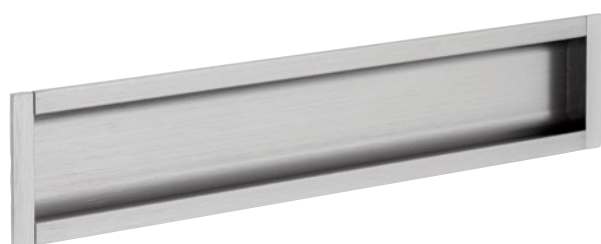

			furattávolság C (mm)	L hossz (mm)	bemélyedés mérete (bemarás) (mm)
ezüst fényes	króm matt	nikkel csiszolt			
37331	37332	37333	96	109	103 × 36 × 14
157776	157777	157778	128	140	137 × 36 × 14
37191	37192	37193	160	171	167 × 36 × 14

Malena



		furattávolság C (mm)	L hossz (mm)	bemélyedés mérete (bemarás) (mm)
eloxált alumínium	rozsdamentes acél imitáció			
226997	226999	96	104	98 × 38 × 9
226998	227000	192	215	209 × 38 × 9

Elsősorban tolóajtókhoz tervezett modell.



Kis vastagságának köszönhetően a Malena fogantyúk 18 mm vastag tolóajtókon is használhatók.

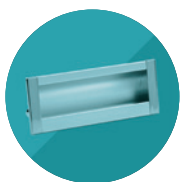

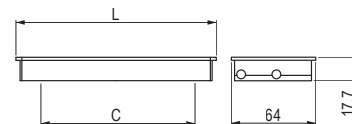

Anetta

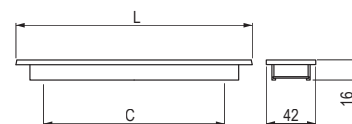
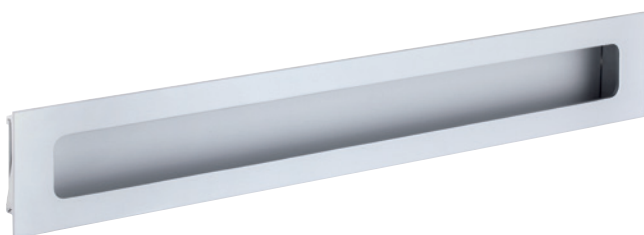

 eloxált alumínium	furattávolság C (mm)	L hossz (mm)	bemélyedés mérete (bemarás) (mm)
37870	96	120	114 × 57,5 × 14,5
37871	128	150	4.81 × 57,5 × 14,5
37872	160	190	184 × 57,5 × 14,5

Rulida





 eloxált alumínium	furattávolság C (mm)	L hossz (mm)	bemélyedés mérete (bemarás) (mm)
37006	128	145	136 × 33 × 14
37007	256	278	267 × 33 × 14
37008	320	337	327 × 33 × 14
37009	544	561	556 × 33 × 14

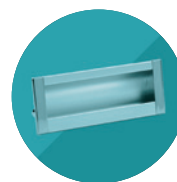



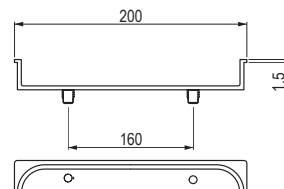

Helena

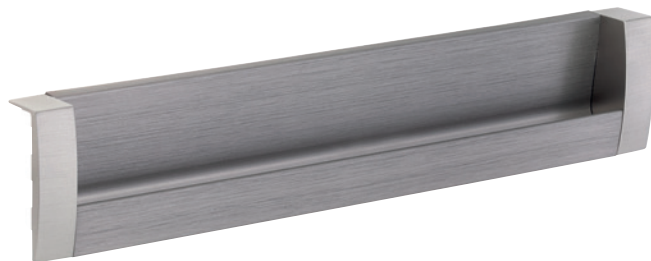

 rozsdamentes acél imitáció	furattávolság C (mm)	L hossz (mm)	D szélesség (mm)	H magasság (mm)
283970	160	200	17	20

Pista



 rozsdamentes acél imitáció	furattávolság C (mm)	L hossz (mm)	bemélyedés mérete (bemarás) (mm)
206136	128	143	137 × 38 × 14
206137	192	207	201 × 38 × 14
206138	320	335	329 × 38 × 14
206139	különálló profil 1000 mm		
202853	végzáró a 206139 profilhoz – balra		
202854	végzáró a 206139 profilhoz – jobbra		

Unta

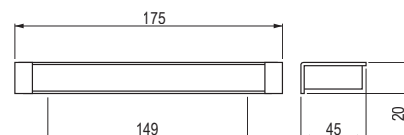

 króm matt	bemélyedés mérete (bemarás) (mm)
289669	164 × 40 × 15

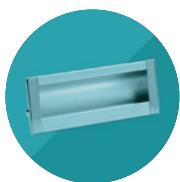

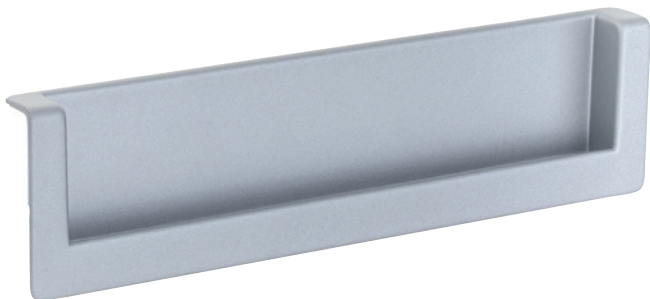

Rapid



	furattávolság C (mm)	L hossz (mm)	bemélyedés mérete (bemarás) (mm)
ezüst	160	171	167 × 40 × 12,5
215529			

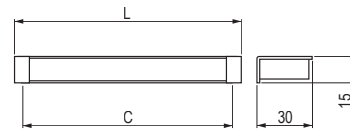
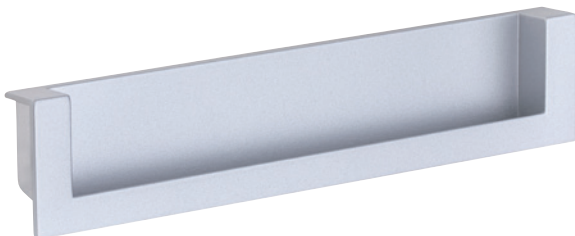

Orinoco

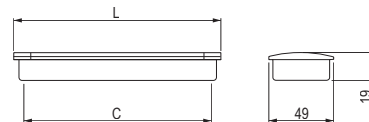
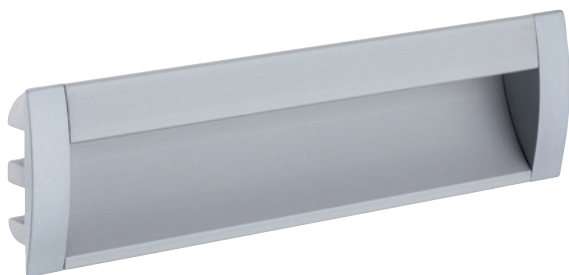

	furattávolság C (mm)	L hossz (mm)	bemélyedés mérete (bemarás) (mm)
ezüst	96	106	102 × 27 × 11
157785			
37201	128	138	134 × 27 × 11

Maluka



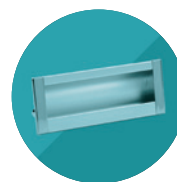

		furattávolság C (mm)	L hossz (mm)	bemélyedés mérete (bemarás) (mm)
eloxált alumínium	rozsdamentes acél imitáció			
157510	157514	128	143	138 × 42,3 × 14,2
157511	157515	160	175	170 × 42,3 × 14,2
157512	157516	192	207	202 × 42,3 × 14,2
157513	157517	256	271	266 × 42,3 × 14,2



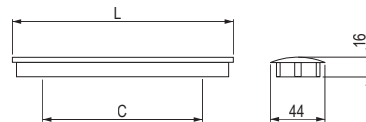

Nave

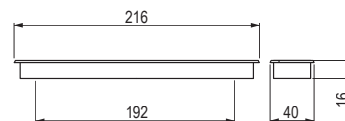

 eloxált alumínium	 rozsdamentes acél imitáció	furattávolság C (mm)	L hossz (mm)	D szélesség (mm)	H magasság (mm)	bemélyedés mérete (bemarás) (mm)
225013	225017	96	106	44	16	101 × 36 × 11
225014	225018	160	170	44	16	166 × 36 × 11
225015	225041	320	330	44	16	326 × 36 × 11
225016	225042	480	490	44	16	487 × 36 × 11

Comola



 króm matt	furattávolság C (mm)	L hossz (mm)	bemélyedés mérete (bemarás) (mm)
205123	192	216	211 × 35 × 14

Elsősorban tolóajtókhoz tervezett modell.

Ilita

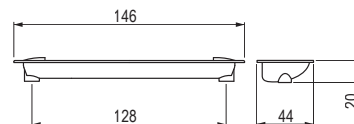



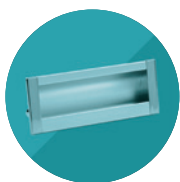

 króm matt	bemélyedés mérete (bemarás) (mm)
289670	140 × 38 × 14

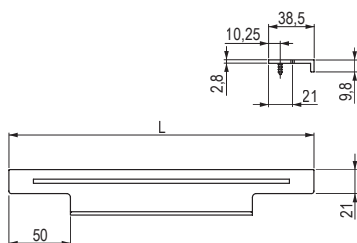





Ramara

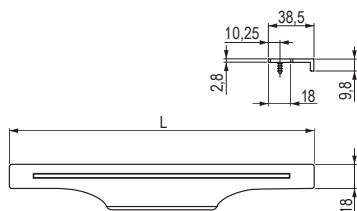

 rozsdamentes acél imitáció	 eloxált alumínium	 fekete matt	 barna matt	L hossz (mm)
244831	244834	366458	354183	146
244832	244835	366459	354184	196
202816	244836	366460	354185	296
202817	244837	366461	354186	346
244833	244838	366462	354187	396
202818	244839	366463	354188	446
202819	244840	366464	354189	496
202820	244841	366465	354190	596
202821	244842	366466	354191	796
202822	244843	366467	354192	896
202823	244844	366468	354193	996
202824	244845	366469	354194	1196

Sophia



 rozsdamentes acél imitáció	 fekete matt	 barna matt	L hossz (mm)
320969	366470	354161	146
320971	366471	354162	196
320974	366472	354163	296
320975	366473	354164	346
320976	366474	354165	396
320977	366475	354166	446
320978	366476	354167	496
320980	366477	354168	596
320981	408029	354169	696
320983	366478	354170	796
320984	366479	354171	896
320985	366480	354172	996
320986	366481	354173	1196

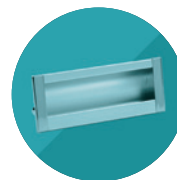

Lucata

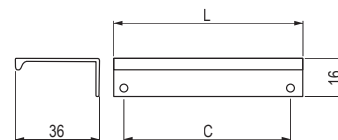

						furattávolság C (mm)	L hossz (mm)
fehér matt	fekete matt	barna matt	króm fényes	rozsdamentes acél imitáció	eloxált alumínium	32	52
360347	360352	354200	227265	227271	227276	64	84
360348	360353	354201	227266	227272	227277	96	116
360349	360354	354202	227267	227273	227278	160	180
360350	360355	354203	227269	227274	227279	320	340
360351	360356	354204	227270	227275	227280	480	500
354155	354154	354157	354158	354153	354152	–	3000
x	x	x	x	x	284334	–	–



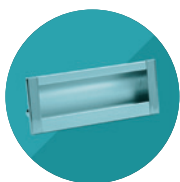

A katalógusban található rápattintható profilok különböző gyártóktól származnak, javasoljuk azonos felületkezelés (= azonos színindex) kombinálását.

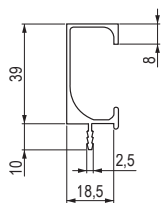

Teppo





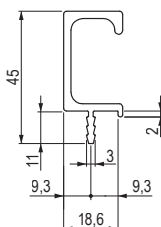
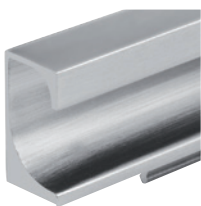

 rozsdamentes acél imitáció	L hossz (mm)
205113	297
205114	347
205115	397
205116	447
205117	497

 rozsdamentes acél imitáció	L hossz (mm)
205118	597
205119	797
205120	897
205121	997
205122	1197

Paolo



 eloxált alumínium	 rozsdamentes acél imitáció	L hossz (mm)
215266	×	297
215267	×	347
215268	×	397
215269	×	447
215270	×	497

 eloxált alumínium	 rozsdamentes acél imitáció	L hossz (mm)
215271	×	597
215272	×	797
215273	×	897
215274	×	997
215275	×	1197
276820	276821	3000 ¹⁾

¹⁾ más méretekkal ellentétben eltérő árnyalata van



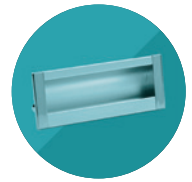

Juvio

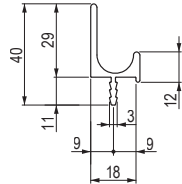

● rozsdamentes acél imitáció	L hossz (mm)	● rozsdamentes acél imitáció	L hossz (mm)
202858	297	202863	597
202859	347	202864	797
202860	397	202865	897
202861	447	202866	997
202862	497	202867	1197

Juvio II

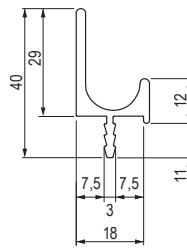

● eloxált alumínium	● rozsdamentes acél imitáció	L hossz (mm)
276815	276814	3000

Maritta

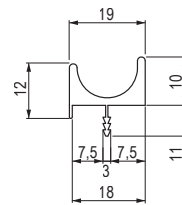

● eloxált alumínium	● rozsdamentes acél imitáció	L hossz (mm)
276816	276817	3000

Rianna

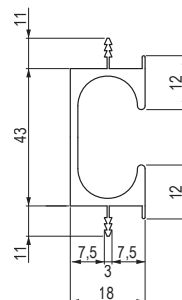

● eloxált alumínium	● rozsdamentes acél imitáció	L hossz (mm)
276818	276819	3000

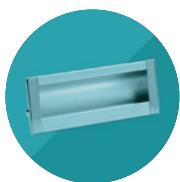

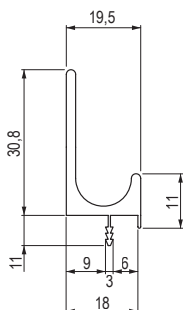

Fano

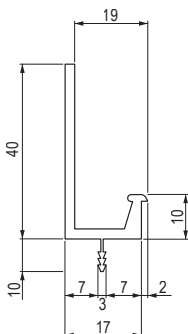

		L hossz (mm)
eloxált alumínium	fekete matt	
UC001	399431	2450

Piano



	L hossz (mm)
eloxált alumínium	
UC002	2450

- fekete matt igényelt méretben megrendelhető

Flata

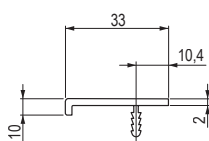

	L hossz (mm)
króm fényes	
36358	70
310665	348
361419	384

Lungo

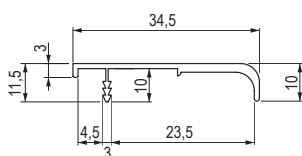

	L hossz (mm)
eloxált alumínium	
UC004	2950

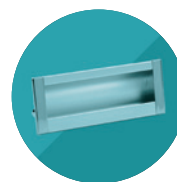

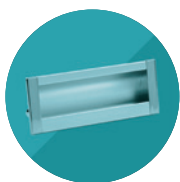

Gola rendszer

- Az ajtók fogantyú nélküli nyitása. Tartalmaz vízszintes (alkalmazás konyhákba) és függőleges profilokat (gardrób szekrényekhez).



vízszintes „J” ajtóprofil

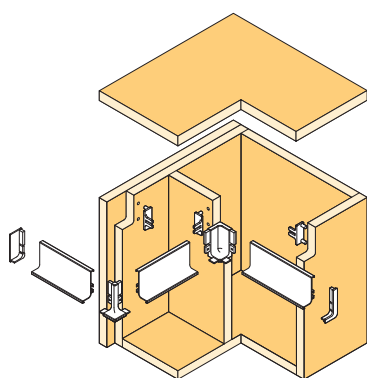

vízszintes „C” fiókprofil

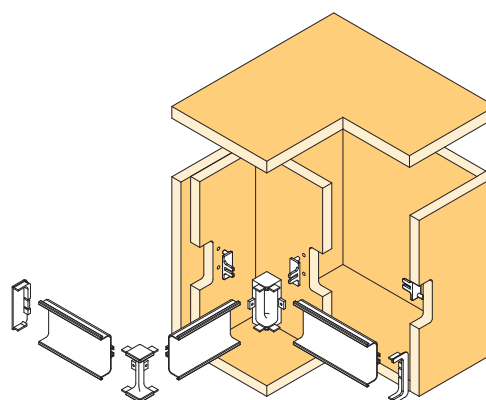

függőleges profilok (oldal és középre)

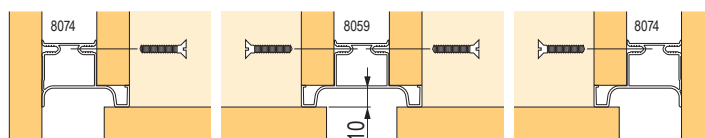

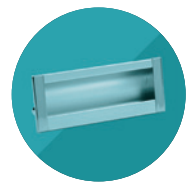

Vízszintes Gola profilok

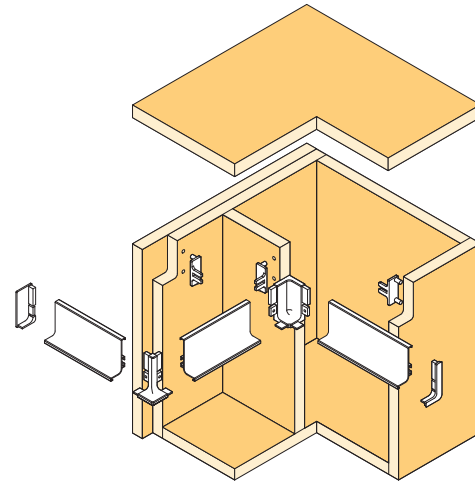
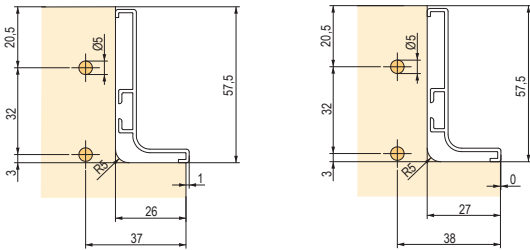

J ajtóprofil 4 100 mm

rozsdamentes acél imitáció	eloxált alumínium	fehér fényes	fekete matt
228304	151631	284149	404389

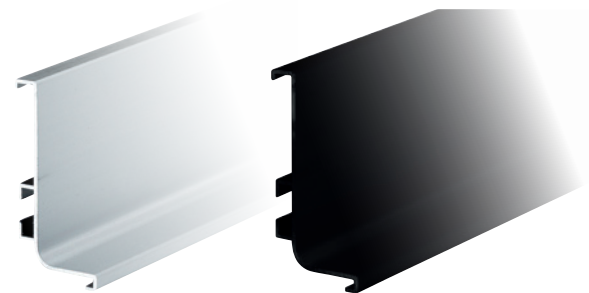

- Profil munkalap alá

- a megadott szerelési méretek érvényesek, ha a profil átnyúlása meghaladja az 1 mm-t
- amennyiben a profil síkba akarja szerelni növelje 1-el (37⇒38, 26⇒27)

Nyitott ajtóprofil végzáró

ezüst műanyag	fehér fényes műanyag	fekete műanyag	rozsdamentes acél imitáció	eloxált alumínium	fekete fém
232861	289124	404394	228305	151632	404397

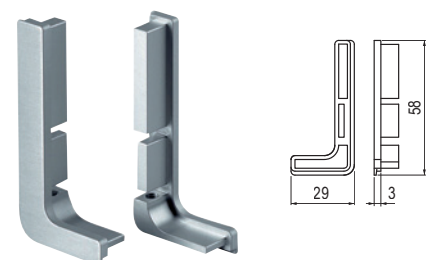

- J + B végzáró szett

Zárt ajtóprofil végzáró

ezüst műanyag	fehér fényes műanyag	fekete műanyag	rozsdamentes acél imitáció	eloxált alumínium	fekete fém
284152	289121	404392	284150	284151	404399



- J + B végzáró szett

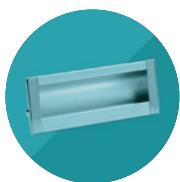

Külső sarok ajtóprofilhoz

rozsdamentes acél imitáció	eloxált alumínium	fehér fényes	fekete műanyag
228306	151717	284153	404393

- anyag: alumínium

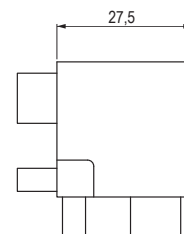

Belső sarok ajtóprofilhoz

rozsdamentes acél imitáció	eloxált alumínium	fehér fényes	fekete műanyag
228307	151718	284154	404391

- anyag: alumínium

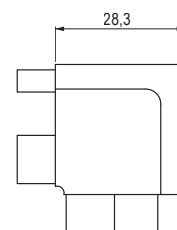

C fiókprofil 4 100 mm

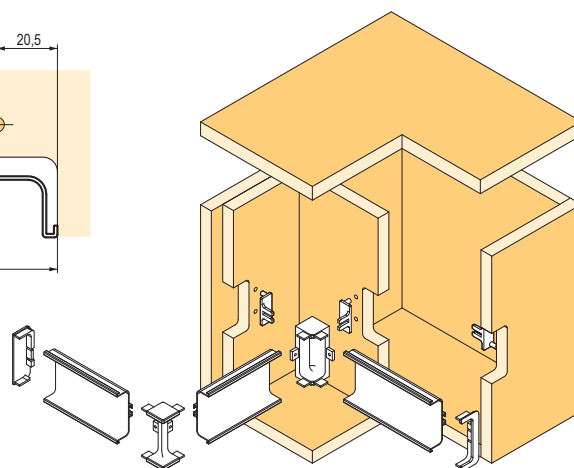
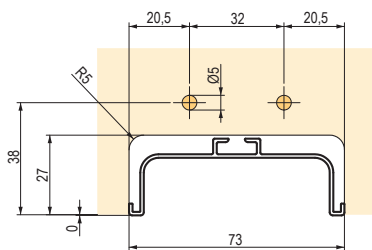
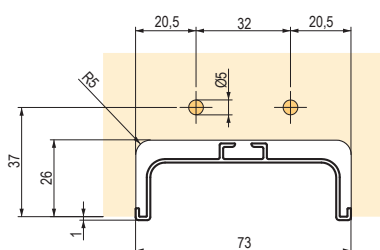





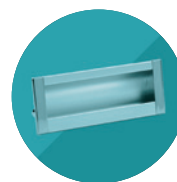

rozsdamentes acél imitáció	eloxált alumínium	fehér fényes	fekete matt
228308	151732	284155	404404

- egymás feletti fiókok közé alkalmazható profil
- a megadott szerelési méretek érvényesek, ha a profil átnyúlása meghaladja az 1mm-t
- amennyiben a profilt síkba akarja szerelni növelje 1-el (37 ⇒ 38, 26 ⇒ 27)









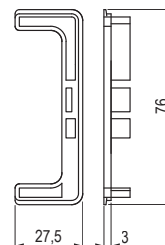

Nyitott fiókprofil végzáró

					
ezüst műanyag	fehér fényes műanyag	fekete műanyag	rozsdamentes acél imitáció	eloxált alumínium	fekete fém
232862	289123	404414	228309	151785	404415



- J + B végzáró szett
- csak akkor alkalmazható, ha a profil nem szekrények oldalai között van



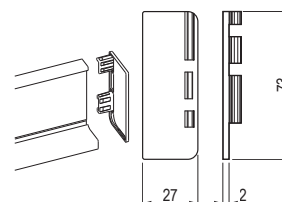

Zárt fiókprofil végzáró

					
ezüst műanyag	fehér fényes műanyag	fekete műanyag	rozsdamentes acél imitáció	eloxált alumínium	fekete fém
284158	289122	404406	284156	284157	404417



- J + B végzáró szett
- csak akkor alkalmazható, ha a profil nem szekrények oldalai között van



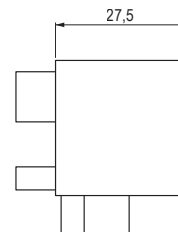

Külső sarok fiókprofilhoz

			
rozsdamentes acél imitáció	eloxált alumínium	fehér fényes	fekete fényes
228310	151786	284159	404413

- anyag: alumínium



Belső sarok fiókprofilhoz

			
rozsdamentes acél imitáció	eloxált alumínium	fehér fényes	fekete matt
228311	151821	284160	404405

- anyag: alumínium

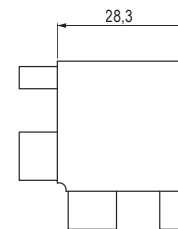

Fiók és ajtóprofil rögzítő-rögzítőelem

műanyag	műanyag, rögzítőelem tuskéval
270092	342984

- 2 rögzítőelem szett a profil rögzítéséhez a szekrény oldalához
- az helytakarékos megoldás lehetővé teszi a profil szerelését már beépített szekrényekbe

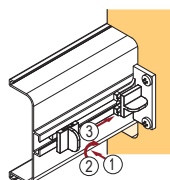

270092

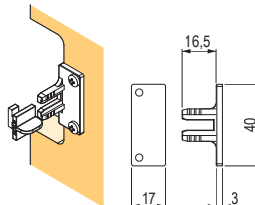

342984

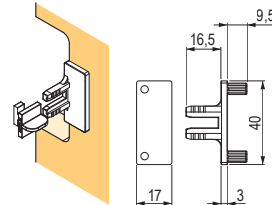

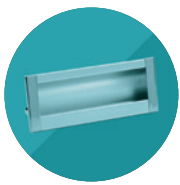

Függőleges Gola profilok

- profilok szekrényajtók fogantyú nélküli nyitásához
- 2 típus áll rendelkezésre oldalra és középre szerelhető
- beépítés 4,2 mm-es önmetsző csavarral

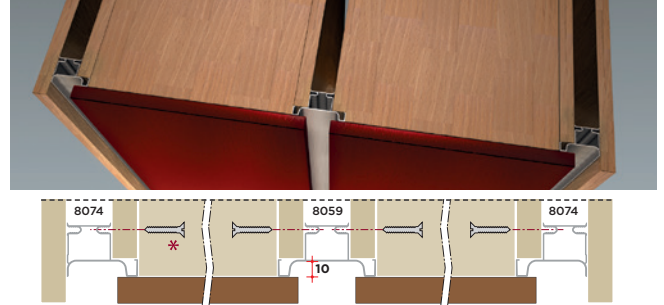

Oldalra szerelhető profil 4 500 mm

rozsdamentes acél imitáció	eloxált alumínium	fehér fényes	fekete matt
284161	235811	284162	404419

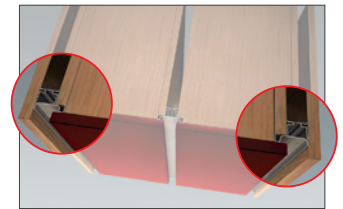
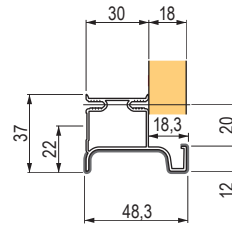

Középre szerelhető profil 4 500 mm

rozsdamentes acél imitáció	eloxált alumínium	fehér fényes	fekete matt
284163	235812	284164	404418

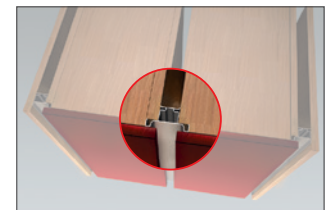
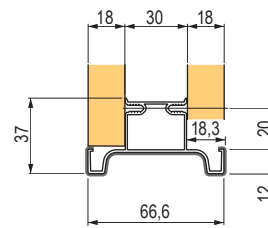

Ajtóprofilok felső szekrényekhez

rozsdamentes acél imitáció	eloxált alumínium	fehér fényes
228312	156848	360875

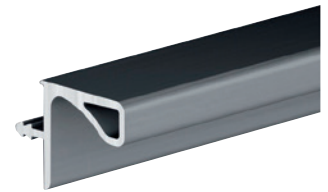
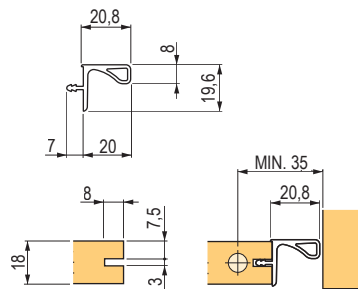

Ajtóprofil 3 900 m, felső szekrényekhez tömítéssel

	vastagsághoz (mm)
366368	18
302379	16

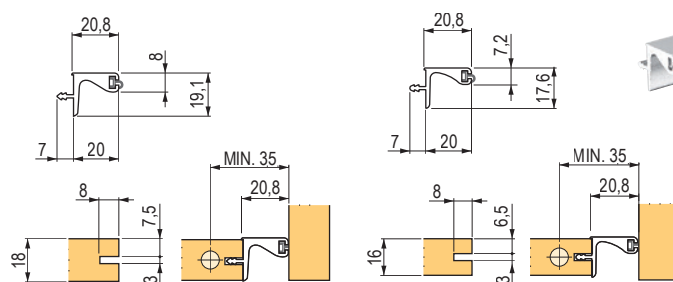

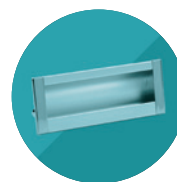

Rápattintható profil anyag va. 18 mm



● eloxált alumínium	L hossz (mm)
CD0051	2 450
313756	2 900

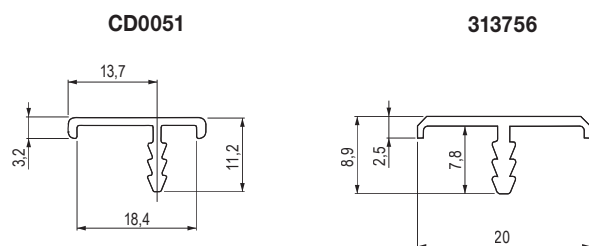

Profil konyhalapokhoz va. 38 mm

● eloxált alumínium	L hossz (mm)
A0093	3 500

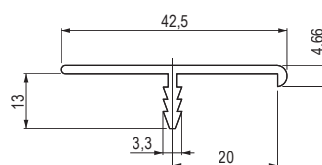

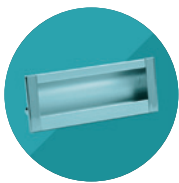
**J ajtóprofil 2 900 mm**

Profil munkalap alá

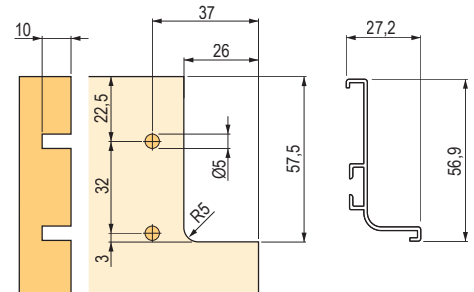
rozsdamentes
acél imitáció**313754**eloxált
alumínium**313753****Nyitott ajtóprofil végzáró**eloxált
alumínium**313757**

- J + B végzáró szett
- csak akkor alkalmazható, ha a profil nem szekrények oldalai között van

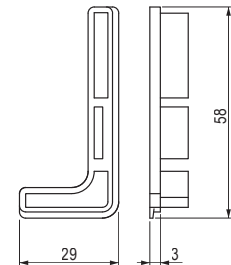
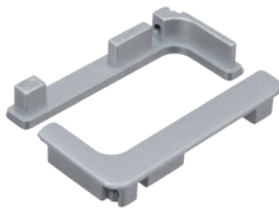
**Külső sarok ajtóprofilhoz**

eloxált alumínium

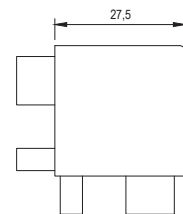

313760**Belső sarok ajtóprofilhoz**

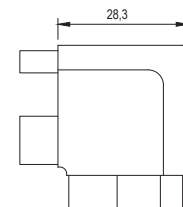
eloxált alumínium

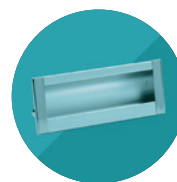
313759



C fiókprofil 2 900 mm

	
rozsdamentes acél imitáció	eloxált alumínium
313752	313751

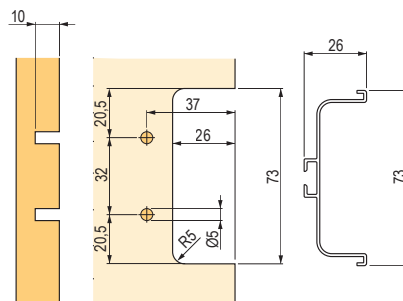

Nyitott fiókprofil végzáró

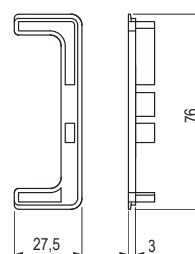
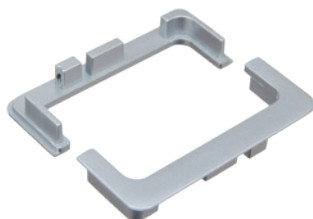

eloxált alumínium
313758

- J + B végzáró szett
- csak akkor alkalmazható, ha a profil nem szekrények oldalai között van

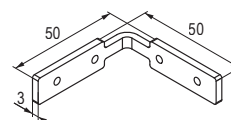

Fiók és ajtóprofil rögzítőegység

műanyag
313762



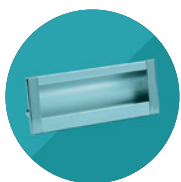

FOGANTYÚK ÉS FOGASOK

fa fogantyúk és bútorgombok

TULIP

Tulip fa fogantyúk és bútorgombok





N Beam

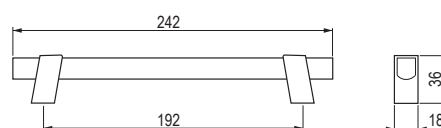

lakkozott tölgy
402330

Metra

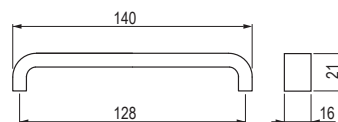

lakkozott tölgy
351899



lakkozott fenyő
351901



lakkozott bükk
351900



lakkozott éger
351902

Berga

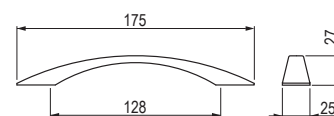

lakkozott tölgy
09459



lakkozott fenyő
09460



lakkozott bükk
09461



lakkozott éger
09462



N Wave

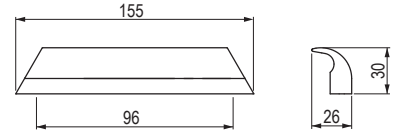

natúr tölgy

404347

lakkozott tölgy

404348

N Square

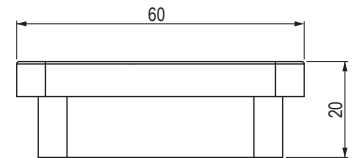

natúr tölgy

404337

lakkozott tölgy

404338

fekete

404341

bükk

404339

lakkozott bükk

404340

fehér

404342

N Oblong

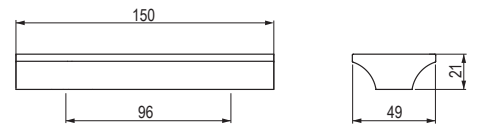
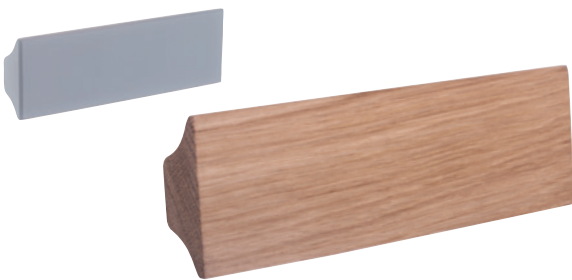
tölgy szürke
pácolt**404346**

natúr tölgy

404343

lakkozott tölgy

404344

tölgy fehér pácolt

404345

N Taper

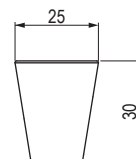

natúr tölgy

404331

lakkozott tölgy

404332

fekete

404335

bükk

404333

lakkozott bükk

404334





fehér

404336

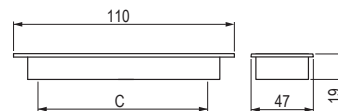



Vasca

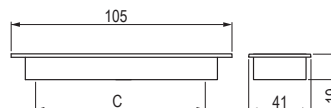

				bemélyedés mérete (bemarás) (mm)	mélység (mm)
natúr tölgy	bükk	natúr juhar	natúr luc		
351888	351889	351890	351891	100 × 40 × 13,5	13,5

Trogola



		bemélyedés mérete (bemarás) (mm)	mélység (mm)
natúr tölgy	bükk		
351896	351897	100 × 40 × 13,5	13

Bustyna

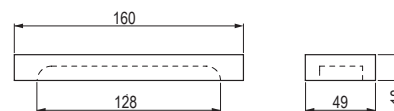

	bemélyedés mérete (bemarás) (mm)	mélység (mm)
bükk		
284817	150 × 39 × 12	11,5













Jacek

						
						
lakkozott tölgy	lakkozott fenyő	lakkozott bükk	lakkozott éger	natúr fenyő	natúr bükk	
09401	09402	09403	09404	158698	158699	

Adam

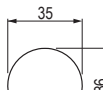
						
						
lakkozott tölgy	lakkozott fenyő	lakkozott bükk	lakkozott éger	natúr fenyő	natúr bükk	
09409	09410	09411	09412	158703	158704	

Olza

				
				
lakkozott fenyő	lakkozott bükk	natúr fenyő	natúr bükk	
09406	09407	158700	158701	

Jura

				
				
lakkozott tölgy	lakkozott fenyő	lakkozott bükk	lakkozott éger	
09413	09414	09415	09416	



Bala

Színes fa

							
sötétkék	világoskék	piros	rózsaszín	narancssárga	lila	zöld	olíva
212674	09497	09489	09490	158702	09491	09492	09493

Sola

Színes fa

						
világoskék	piros	rózsaszín	narancssárga	zöld	olíva	sárga
158717	158718	158719	158720	158721	158722	158723





FOGANTYÚK ÉS FOGASOK

**gyermek- és műanyag fogantyúk
és bútorgombok**

TULIP

Tulip gyermek és műanyag
fogantyúk és bútorgombok



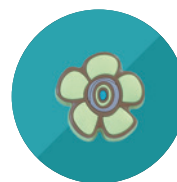



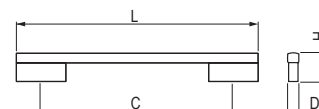
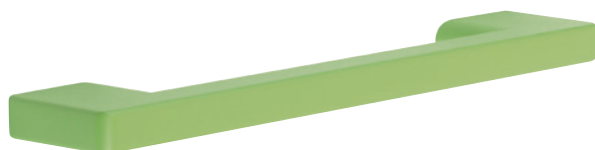

Cana

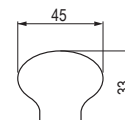

				furattávolság C (mm)	L hossz (mm)	D szélesség (mm)	H magasság (mm)
rózsaszín	zöld	fehér	világoskék				
303198	303202	303210	303206	96	122	9	26
303199	303203	303211	303207	128	150	9	29
303200	303204	303212	303208	160	200	9	30

Funga



			
rózsaszín	zöld	fehér	világoskék
303233	303234	303236	303235

Modo Q

Lágyított műanyag

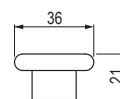



fehér
284533

**Modo R**

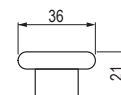
Lágyított műanyag

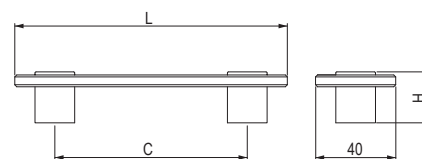

fehér

284536**N Cute**

szürke/fehér

405137

kék/fehér

405138

rózsaszín/fehér

405139furattávolság
C (mm)

96

L
hossz
(mm)

136

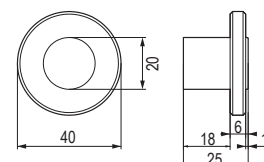
N Cute

szürke/fehér

405148

kék/fehér

405149

rózsaszín/fehér

405150

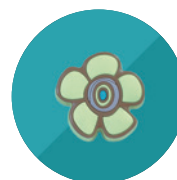

Bottone

Edzett műanyag



			L hossz (mm)	D szélesség (mm)	H magasság (mm)
					
fehér	kék	rózsaszín	58	58	23
351883	351884	351885			

Spaccata

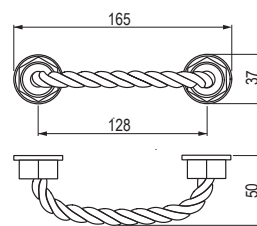

barna kótél

351879

N Spaccata

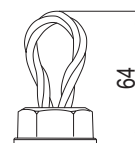

barna kótél

382066



P431

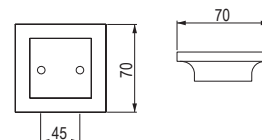

fehér

265483



zöld

265485

P439

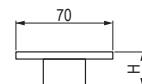

fehér

265486



zöld

265488

Ema

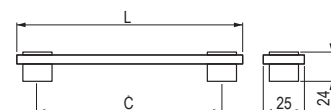

narancssárga

303217



zöld

303219



fehér

303215



kék

303213

furattávolság
C (mm)

128

L
hossz
(mm)

150

303218

303220

303216

303214

160

183

Ema

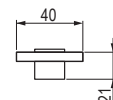
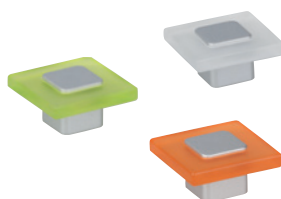

narancssárga

303223



zöld

303224



fehér

303222



kék

303221



Palla

Puha műanyag





	L hossz (mm)	D szélesség (mm)	H magasság (mm)
motívum			
198702	40	40	28

Fiora

Puha műanyag



		L hossz (mm)	D szélesség (mm)	H magasság (mm)
rózsaszín	sárga			
222116	222117	44	44	23

Fisk

Puha műanyag

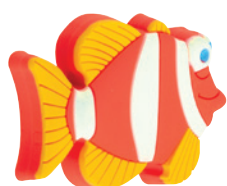

	L hossz (mm)	D szélesség (mm)	H magasság (mm)
motívum			
101074	53	39	24

Rana

Puha műanyag



	L hossz (mm)	D szélesség (mm)	H magasság (mm)
motívum			
198704	45	50	23



Chat



Puha műanyag



 motívum	L hossz (mm)	D szélesség (mm)	H magasság (mm)
198703	51	35	24

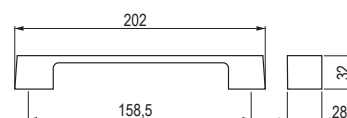

M306

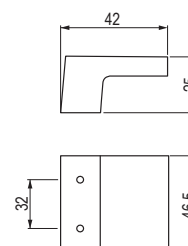
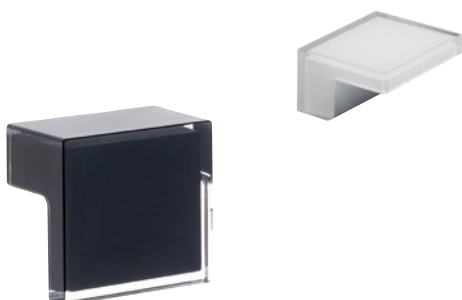

	
fehér	fekete
265479	265480

P603





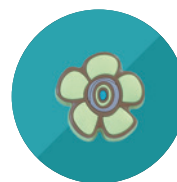

	
fehér	fekete
265471	265473

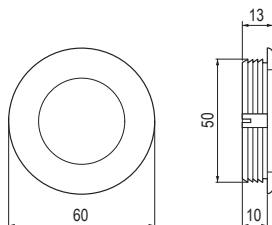







N Into

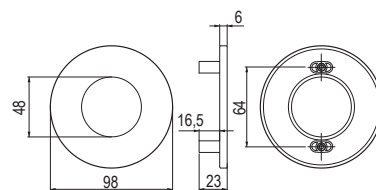

				
fehér	szürke	fekete	rózsaszín	kék
405152	405153	405154	405155	405156

N Large



				
fehér	szürke	fekete	rózsaszín	kék
405157	405158	405159	405160	405161







Tulip
fogasok





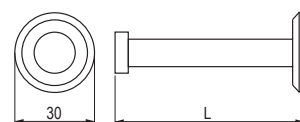

Filip



 csiszolt nemesacél	hossz NL L (mm)
372855	52
352456	72

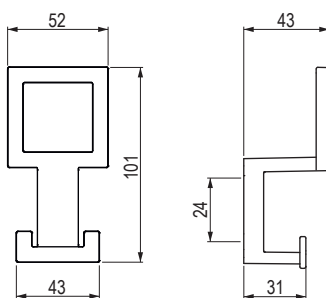

 Marell

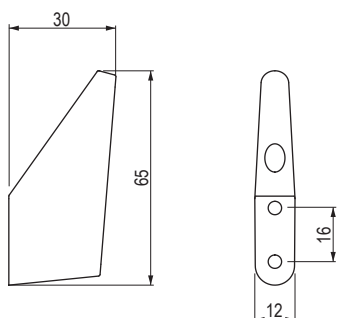

 fekete matt	 nikkelt csiszolt
398004	398005

 Level



 fekete matt	 króm fényes	 nikkelt matt
402386	402387	402399



N Rini

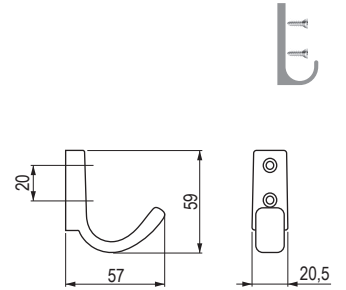

fekete matt

399539

N Rini XL

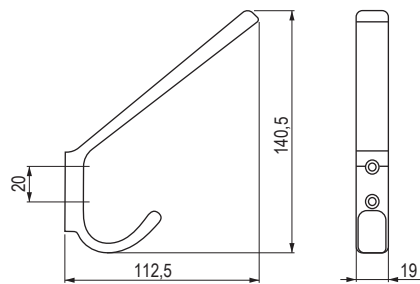

fekete matt

399538

Pera

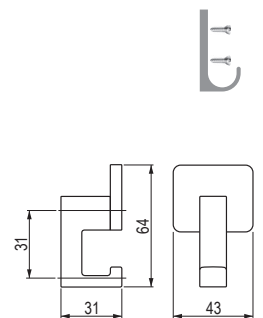

eloxált alumínium

77812



nikkelt csiszolt

77813



fekete matt

356378



antracit matt

399804



fehér matt

356377



arany matt

399803



Ruza



					D szélesség (mm)	H magasság (mm)
nikkel matt	króm matt	króm fényes	nikkel csiszolt	fekete matt	16	27
157289	157290	157292	157291	157293	21	35
157294	157295	157297	157296	157299		

N Balo

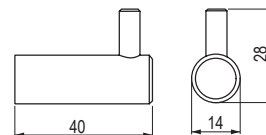

fekete matt

398940

N Balo XL

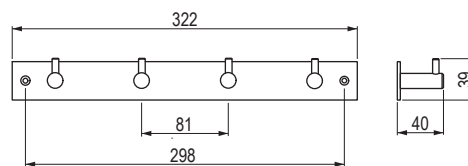

fekete matt

398939



Kara S

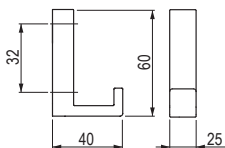

ófekete	nikkel csiszolt	króm fényes	fekete matt	fehér matt
351874	284988	284991	355732	355729



Kara M

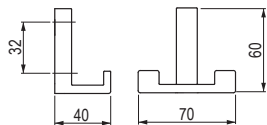

ófekete	nikkel csiszolt	króm fényes	fekete matt	fehér matt
351873	284989	284992	355731	355728



Kara L

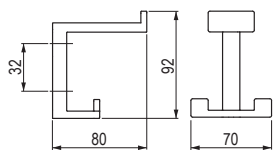

ófekete	nikkel csiszolt	króm fényes	fekete matt	fehér matt
351872	284990	284993	355730	355727



Doris

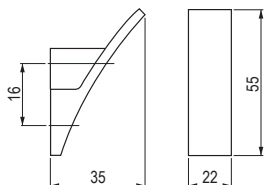

króm fényes	króm matt	nikkel matt
204686	204687	204688





Rocata

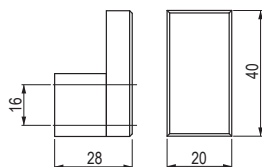

fekete matt

284108

Laura

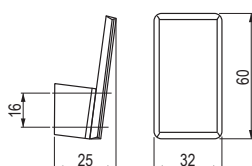

fekete matt

320988

N Glen

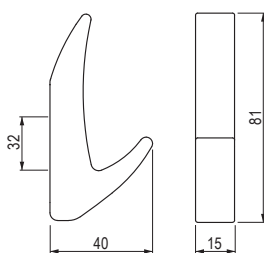

króm fényes

398574



nikkel csiszolt

398575



ófekete

398576



óbronz

398577

N Glen XL

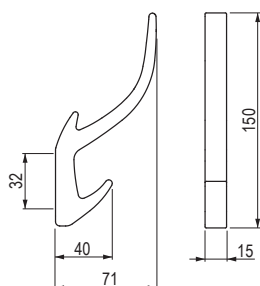

króm fényes

398570



nikkel csiszolt

398571



ófekete

398572



óbronz

398573



Belluna

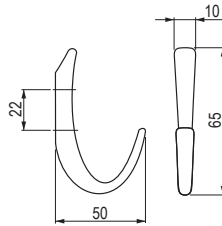

króm fényes

157323

króm matt

157321

nikkel csiszolt

157322

fekete fényes

351730

fehér fényes

351731

Belluna XL

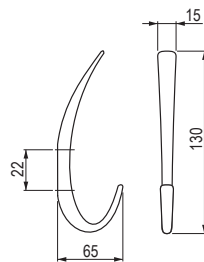

króm fényes

157326

króm matt

157324

nikkel csiszolt

157325

fekete fényes

351732

fehér fényes

351733

Honza

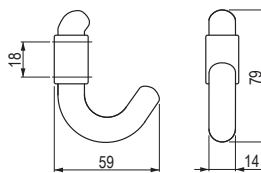
rozsdamentes
acél imitáció**10460**

króm matt

10462

Honza XL

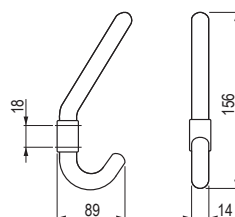
rozsdamentes
acél imitáció**10463**

króm matt

10465



Dona

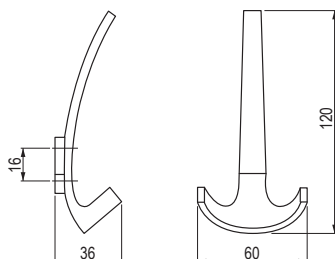

króm matt	nikkel matt
202856	202857

Fera

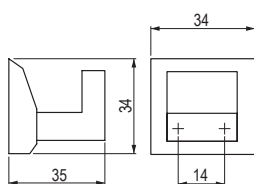

króm matt
35991

Victory

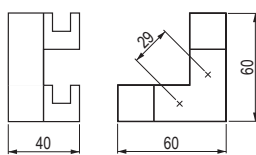

eloxált alumínium
77827

Dyan

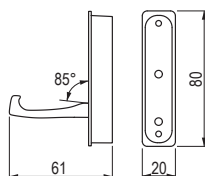

nikkel matt	króm matt	króm fényes
231588	231589	231590



Dax

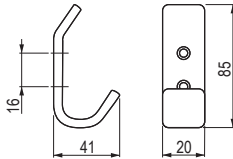

króm matt	nikkel matt
157327	157328

Extendo

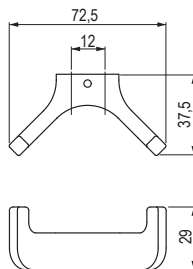

króm fényes	króm matt	nikkel csiszolt
283964	283965	283966

Extendo XL

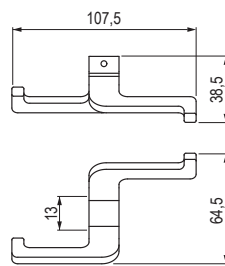

króm fényes	króm matt	nikkel csiszolt
283967	283968	283969

Iwo

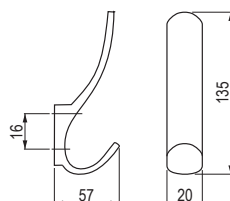

nikkel matt	króm matt
289683	289684



Marcel

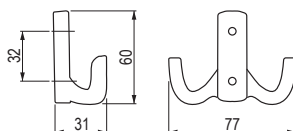

króm fényes	króm matt	nikkel matt
290153	290154	290155



Marcel XL

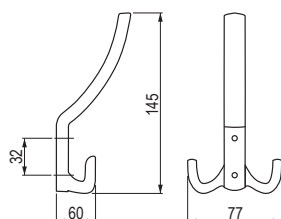

króm fényes	króm matt	nikkel matt
290150	290151	290152



Darec

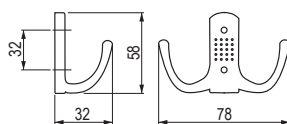

króm fényes	króm matt	nikkel matt
289679	289680	360922



Darec XL

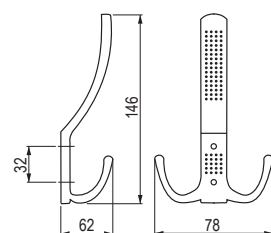

króm fényes	króm matt	nikkel matt
289677	289678	360920





Mela

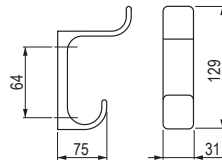

eloxált alumínium

77800

Rokos

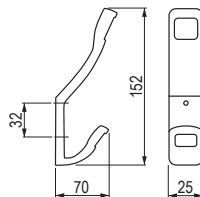

nikkel matt

289681



króm matt

289682

Trias

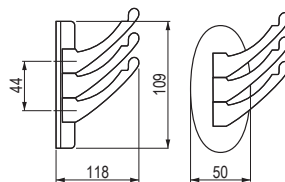

nikkel matt

289674

Rapallo

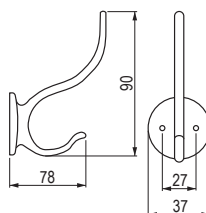

nikkel matt

35621



króm matt

35622



fekete

35625



Franca

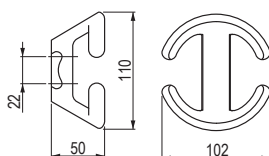

ezüst

77815



króm matt

77814



Ilan

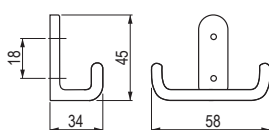

króm matt

289688



nikkel matt

08952



Ilan XL

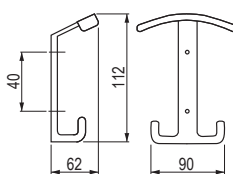

nikkel matt

289689



Tarasa

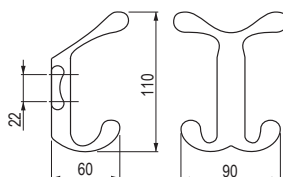
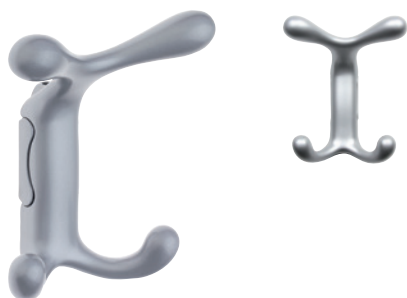

eloxált alumínium

77806





Roberto

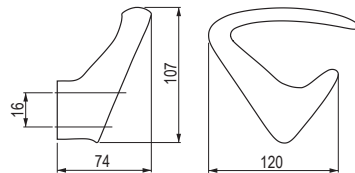

eloxált alumínium

77818

Carpo

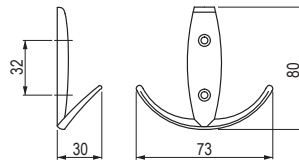

króm matt

157313



nikkel csiszolt

157315



nikkel matt

157316

Livorno

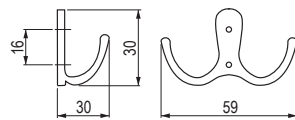

nikkel matt

35611



króm matt

35612



króm fényes

35613



fekete matt

35615

Petros

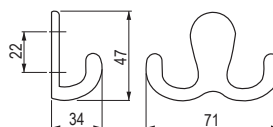

króm matt

226991



Lerico

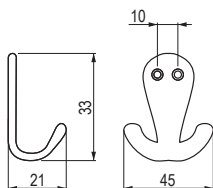

króm matt	nikkel matt	króm fényes
157330	157331	157332



Muso

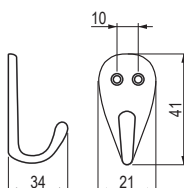

króm matt	nikkel matt	króm fényes
157333	157334	157335



Unico

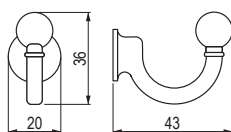

nikkel matt	króm matt	króm fényes
35571	35572	35573



Tamos

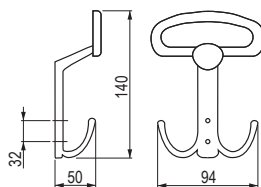

nikkel matt	króm matt
35601	35602





Lugo

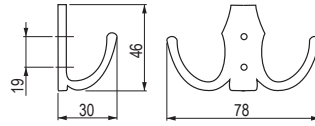

nikkel matt	króm matt	króm fényes	arany fényes	fekete matt
35591	35592	35593	35594	35595

Lugo XL

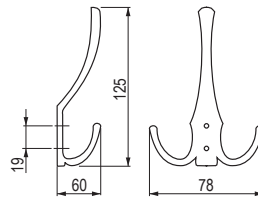

nikkel matt	króm matt	króm fényes	arany fényes	fekete matt
35581	35582	35583	35584	35585

Locarno

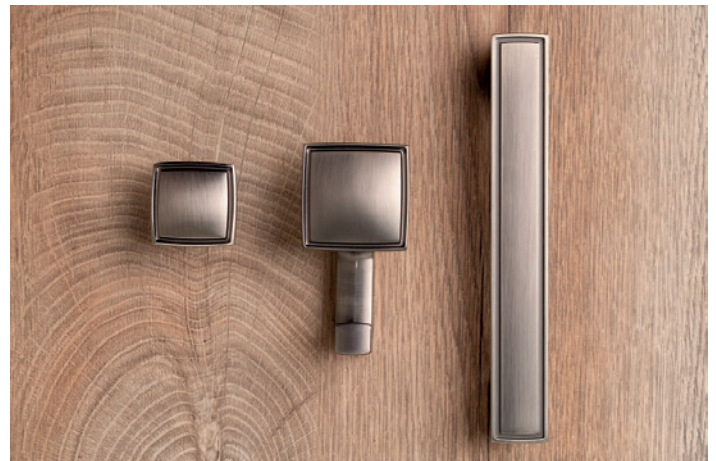

fogantyú (old. 4.74)



bütorgomb (old. 4.74)

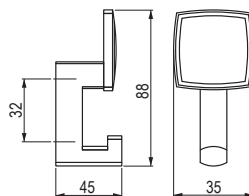

óarany	ócink csiszolt
284314	284315



Murero

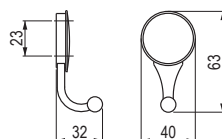



	
óarany	ófekete
157317	157318

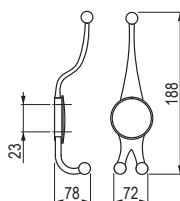

Murero XL







	
óarany	ófekete
157319	157320

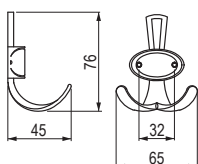

Rubico





			
ófekete	óarany	óréz sötét	ócinck csiszolt
157309	157310	226969	226967

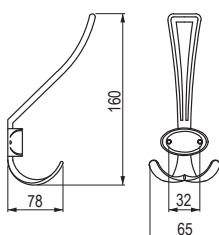

Rubico XL



		
ófekete	óarany	óréz sötét
157311	157312	226976





Orio

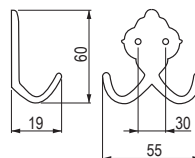

óarany

36769



Orio XL

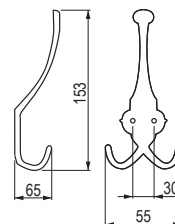

óarany

36768



Treka

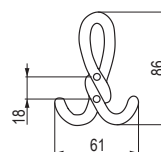

óarany

351945



Arpi

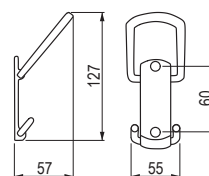

ófekete

351881





Petr

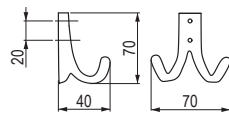
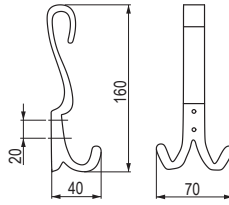

leírás	ófekete	furattávolság C (mm)
kicsi	355803	20
nagy	355805	20

Pavel

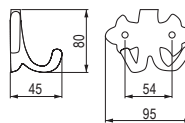
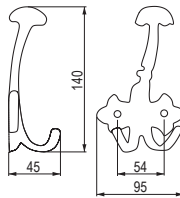

leírás	ófekete	furattávolság C (mm)
kicsi	355806	54
nagy	355807	54

Barra



ófekete	furattávolság C (mm)	L hossz (mm)	D szélesség (mm)	H magasság (mm)
351898	384	399	75	20

Towelo

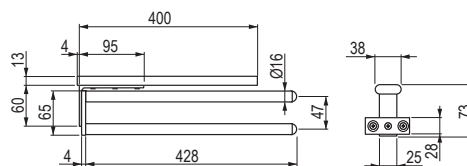

előxált alumínium
36725



FOGANTYÚK ÉS FOGASOK

fogantyúk, bútorgombok és fogasok

MARELLA
100% MADE IN ITALY

Marella
Design



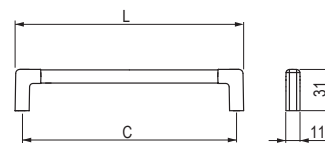
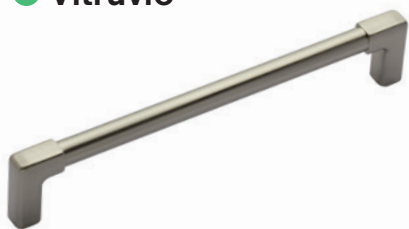

N Vitruvio

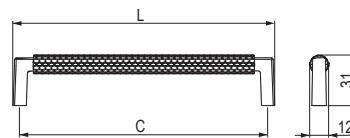
			furattávolság C (mm)	L hossz (mm)
405057	405059	405061	160	170,6
405058	405060	405062	320	330,6

N Trama

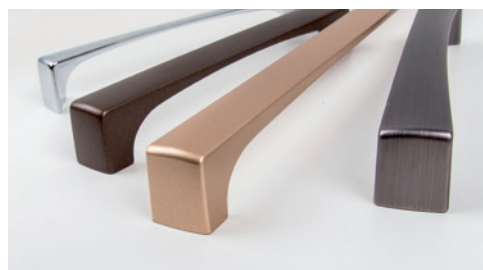
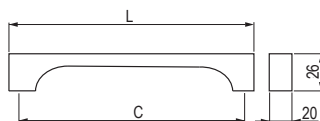
	furattávolság C (mm)	L hossz (mm)
405073	160	168,3
405074	320	328,3

Lama

				furattávolság C (mm)	L hossz (mm)	D szélesség (mm)	H magasság (mm)
356241	356243	356245	356247	160	170	20	26
356240	356242	356244	356246	320	330	20	26



N Tonda

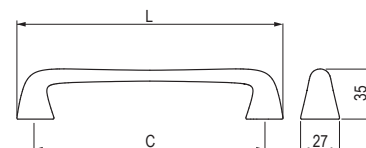

					furattávolság C (mm)	L hossz (mm)
nikkel matt 405044	fekete silk touch 405046	fehér silk touch 405048	szürke silk touch 405050	kék silk touch 405052	160	184,4
405045	405047	405049	405051	405053	320	344,4

extra matt finishes silk effect
BORN TO RESIST.

- resistant to scratches and abrasions
- resistant to cold liquids
- resistant to syntetic sweat
- suitable for humid environments
- anti-fingerprint
- easy to clean
- light stability
- extra matt and anti-glare
- silk effect

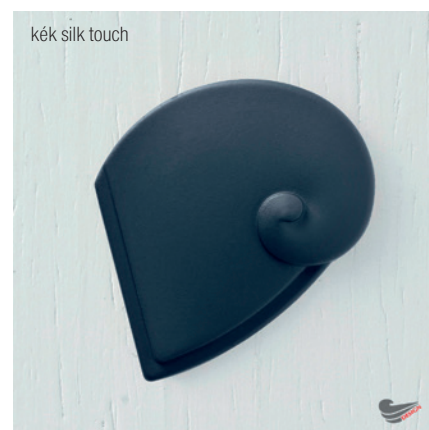

MARELLA
100% MADE IN ITALY



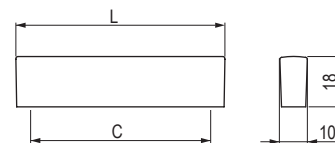

N Linae



		furattávolság C (mm)	L hossz (mm)
fehér silk touch	fekete silk touch	32/64	76
405069	405070	224/256	268
405071	405072		





N Prince

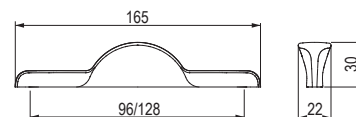

fekete matt

405042



arany matt

405043

Brera

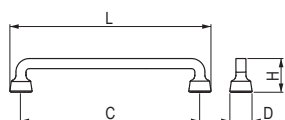

óbronz

356226



fekete matt

356229



arany rozsdamentes acél

405054

furattávolság
C (mm)

L
hossz
(mm)

D
szélesség
(mm)

H
magasság
(mm)

356225

356228

405055

96

116

20

30

356224

356227

405056

320

340

20

30

Caleido

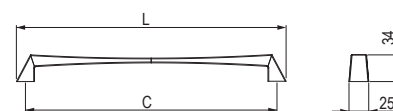

óréz

284263

furattávolság
C (mm)

L
hossz
(mm)

284264

128

149

Caleido

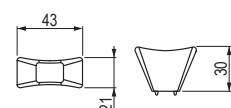
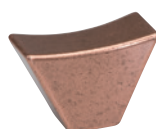

óréz

284266



Arco BM

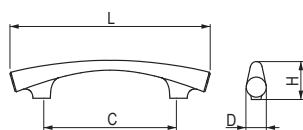

		furattávolság C (mm)	L hossz (mm)	D szélesség (mm)	H magasság (mm)
367290	367291	128	185	19	35
356275	356278	224	281	19	35

• a színárnyalatok eltérhetnek

Defence

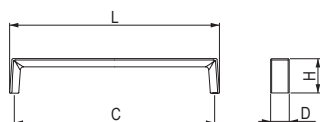

				furattávolság C (mm)	L hossz (mm)	D szélesség (mm)	H magasság (mm)
×	×	356237	356239	96	103	16	28
356233	356235	356236	356238	160	167	16	28
356232	356234	×	×	320	327	16	28

• a színárnyalatok eltérhetnek





Viaggio

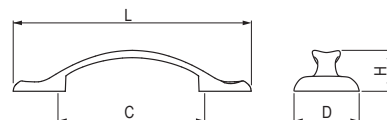

Washed Stone	rozsdahatás	furattávo- ság C (mm)	L hossz (mm)	D szélesség (mm)	H magasság (mm)
356261	356264	96	156	30	27
356260	356263	128	187	30	27

- a színárnyalatok eltérhetnek

Viaggio

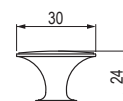

Washed Stone	rozsdahatás
356262	356265

- a színárnyalatok eltérhetnek

Art Deco

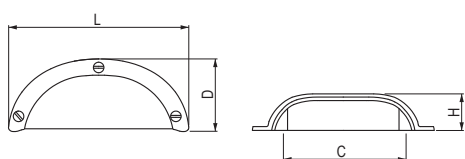

Washed Stone	rozsdahatás	blue washed	furattávo- ság C (mm)	L hossz (mm)	D szélesség (mm)	H magasság (mm)
356272	356273	356274	32	79	32	20
356269	356270	356271	64	95	38	20

- a színárnyalatok eltérhetnek

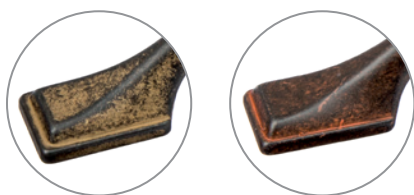
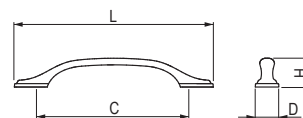

Sirius

Washed Stone	rozsdahatás	ócink	furattávolság C (mm)	L hossz (mm)	D szélesség (mm)	H magasság (mm)
356250	356254	284267	96	142	21	28
356249	356253	284268	128	177	22	29
356248	356252	284269	160	210	25	30

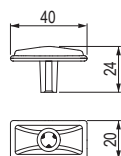
• a színárnyalatok eltérhetnek

Sirius

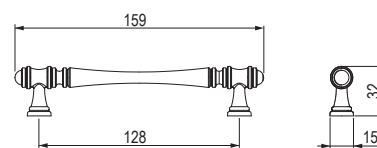
Washed Stone	rozsdahatás	ócink
356251	356255	284270

N Columnae

bronz	ócink	óréz sötét	furattávolság C (mm)	L hossz (mm)
405063	405064	405065	128	159

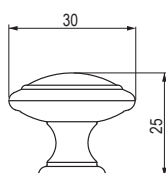
N Columnae

bronz	ócink	óréz sötét
405066	405067	405068



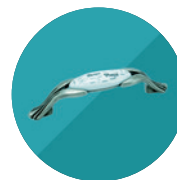

Bosa

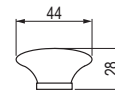

		
porcelán krém	porcelán fehér/ átlátszó	porcelán krém/virág
288053	288054	288055

Venice R

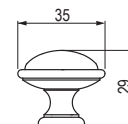

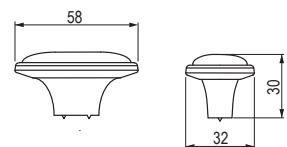

ócsink / porcelán motívum
288058

Venice O

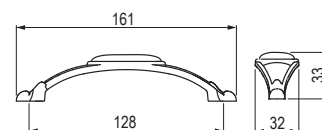

ócsink / porcelán motívum
288057

Venice



ócsink / porcelán motívum
288056



Macis

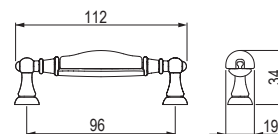

öréz sötét/
fehér porcelán

284279

Macis

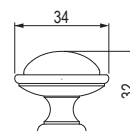

öréz sötét/
fehér porcelán

284280

Lenis

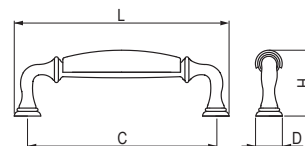

öréz / fehér porcelán	furattávolság C (mm)	L hossz (mm)	D szélesség (mm)	H magasság (mm)
284275	96	111	22	41
284274	128	145	24	48

Lenis

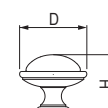

	öréz / fehér porcelán	L hossz (mm)	D szélesség (mm)	H magasság (mm)
L	284276	39	39	34
M	284278	34	34	29



Aramis S

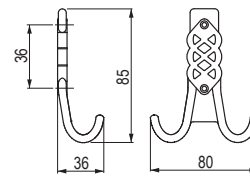

bronz

284271

Aramis M

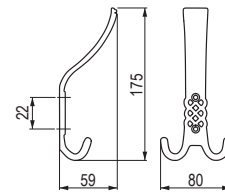

bronz

284273

Oasi

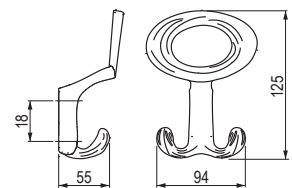

óarany

356222



ócsink

356223

furattávo-
ság
C (mm)

20

L
hossz
(mm)

94

D
szélesség
(mm)

125

H
magasság
(mm)

55

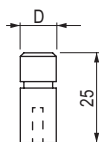

Hettich
rozsdamentes
acél fogantyúk

**N Arnum**

kód	Hettich kód	felület	átmérő D (mm)
409612	9208071	nemesacél	10
409613	9208072	nemesacél	10

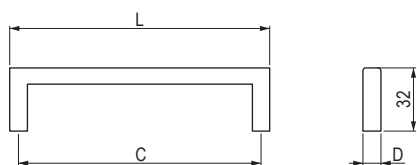
Anzio

kód	Hettich kód	felület	furattávolság C (mm)	L hossz (mm)	D szélesség (mm)
360423	9204164	csiszolt nemesacél	96	106	10
133350	1160018	csiszolt nemesacél	128	138	10
154276	1160019	csiszolt nemesacél	160	170	10
343976	9204175	csiszolt nemesacél	192	202	10
135134	1160020	csiszolt nemesacél	224	234	10
146741	1160021	csiszolt nemesacél	288	298	10
318716	9204177	csiszolt nemesacél	320	330	10
133349	1160022	csiszolt nemesacél	352	362	10
146742	1160023	csiszolt nemesacél	480	490	10
153625	1160024	csiszolt nemesacél	608	618	10
146743	1160025	csiszolt nemesacél	736	746	10
335529	9207348	csiszolt nemesacél	160	172	12
360424	9207356	csiszolt nemesacél	192	204	12
360426	9207349	csiszolt nemesacél	320	332	12
317524	9207350	csiszolt nemesacél	416	428	12
360427	9207351	csiszolt nemesacél	512	524	12
360430	9207352	csiszolt nemesacél	736	748	12
317525	9207354	csiszolt nemesacél	832	844	12



Monacum

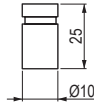

kód	Hettich kód	felület	átmérő (mm)
106762	9070957	csiszolt nemesacél	10
106562	9070958	csiszolt nemesacél	14

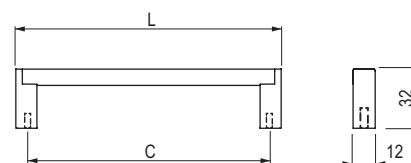
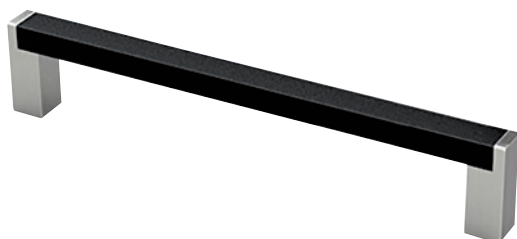
Fém fogantyúk
Hettich**N Bermeo**

kód	Hettich kód	felület	furattávolság C (mm)	L hossz (mm)
409610	9208081	fekete matt/rozsdamentes acél imitáció	96	109
409602	9208082	fekete matt/rozsdamentes acél imitáció	128	141
395157	9208083	fekete matt/rozsdamentes acél imitáció	160	173
409604	9208084	fekete matt/rozsdamentes acél imitáció	192	205
409606	9208085	fekete matt/rozsdamentes acél imitáció	224	137
409608	9208086	fekete matt/rozsdamentes acél imitáció	256	269
395156	9208087	fekete matt/rozsdamentes acél imitáció	288	301
409609	9208088	fekete matt/rozsdamentes acél imitáció	320	333
409611	9208073	rozsdamentes acél imitáció	96	109
409601	9208074	rozsdamentes acél imitáció	128	141
409603	9208075	rozsdamentes acél imitáció	160	173
351797	9208076	rozsdamentes acél imitáció	192	205
409605	9208077	rozsdamentes acél imitáció	224	137
409607	9208078	rozsdamentes acél imitáció	256	269
405113	9208079	rozsdamentes acél imitáció	288	301
320973	9208080	rozsdamentes acél imitáció	320	333

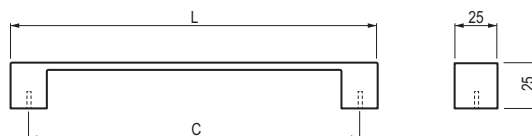
N Cheam

kód	Hettich kód	felület	furattávolság C (mm)	L hossz (mm)
122887	9113212	rozsdamentes acél imitáció	192	227

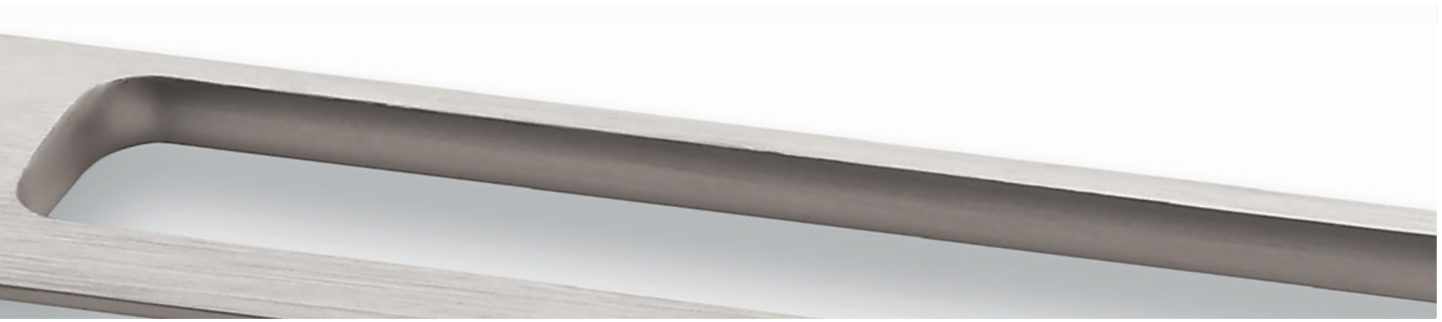
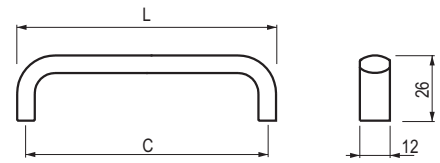
N Naila

kód	Hettich kód	felület	furattávo- ság C (mm)	L hossz (mm)
409631	9190428	barna fémes	64	71
409632	9190429	barna fémes	96	103
409625	9190430	barna fémes	128	135
409626	9190431	barna fémes	160	167
409627	9190432	barna fémes	192	199
409628	9190433	barna fémes	256	263
409629	9190434	barna fémes	288	295
409630	9190435	barna fémes	320	327
409633	9266077	fekete matt	64	71
409634	9266078	fekete matt	96	103
409635	9266079	fekete matt	128	135
409636	9266080	fekete matt	160	167
409637	9266091	fekete matt	192	199
409638	9266092	fekete matt	256	263
409639	9266093	fekete matt	288	295
409640	9266094	fekete matt	320	327

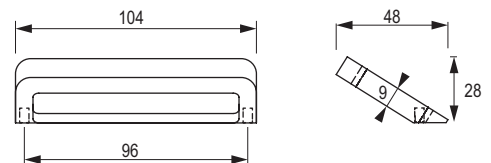
N Buena

kód	Hettich kód	felület	furattávo- ság C (mm)	L hossz (mm)
346637	9207446	réz	96	104

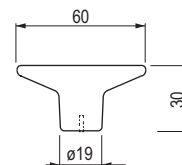
**N Tardiano**

kód	Hettich kód	felület	átmérő D (mm)
409641	9266141	rozsdamentes acél imitáció	60
409642	9266142	fekete matt	60

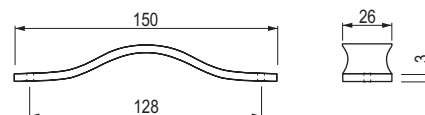
N Gela

kód	Hettich kód	felület	furattávo- ság C (mm)	L hossz (mm)
182316	9113645	világosbarna	128	150
131687	9113646	sötétbarna	128	150
187687	9113647	fekete	128	150

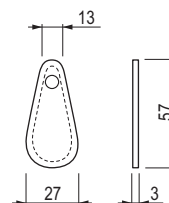
N Galati

kód	Hettich kód	felület	szélesség (mm)	magasság (mm)
409643	9113648	világosbarna	27	57
409644	9113649	sötétbarna	27	57
409645	9113650	fekete	27	57

N Rögzítő elemek a Gela és Galati fogantyúkhöz

kód	Hettich kód	felület
376385	9113651	króm matt
187689	9113652	króm fényes
187690	9113653	nikkel matt
187691	9113654	öbronz

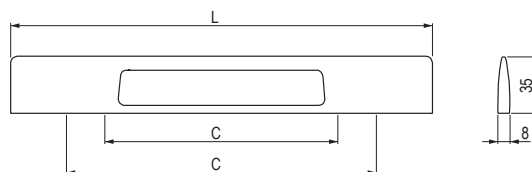
Nubia

kód	Hettich kód	felület	furattávo- ság C (mm)	L hossz (mm)
135770	9105837	rozsdamentes acél imitáció	192	245
132100	9105838	rozsdamentes acél imitáció	256	309
144163	9105839	rozsdamentes acél imitáció	256	373
144164	9105840	rozsdamentes acél imitáció	192/352	437
131308	9106166	króm fényes	192	245
131309	9106167	króm fényes	256	309
161774	9106168	króm fényes	256	373
131310	9106169	króm fényes	192/352	437

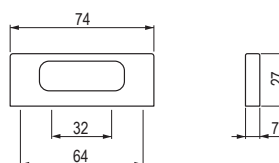
Fermo

kód	Hettich kód	felület	furattávo- ság C (mm)	L hossz (mm)
107413	115020	króm fényes	64/32	74
106987	115019	rozsdamentes acél imitáció	64/32	74



Basilia

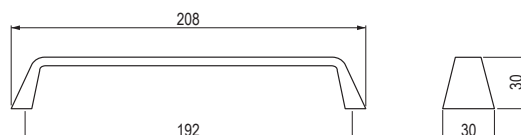

kód	Hettich kód	felület	furattávolság C (mm)	L hossz (mm)
105517	115076	rozsdamentes acél imitáció	192	208

Catana

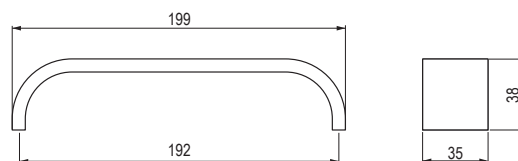

kód	Hettich kód	felület	furattávolság C (mm)	L hossz (mm)
106317	115080	rozsdamentes acél imitáció	192	199

Egara

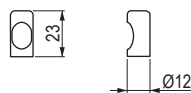

kód	Hettich kód	felület	furattávolság C (mm)	L hossz (mm)
106184	9071719	óarany	128	155
106258	9071720	cink csiszolt	128	155

Almus

kód	Hettich kód	felület	átmérő D (mm)	H magasság (mm)
106827	9112583	króm fényes	12	23
105387	9112588	nikkel matt	12	23
153733	9112590	króm matt	12	23
153736	9114036	rozsdamentes acél imitáció	12	23

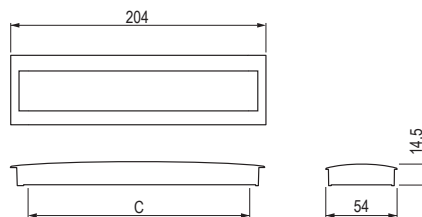
Misnia

kód	Hettich kód	felület	furattávolság C (mm)	L1 hossz (mm)	L2 hossz (mm)
105466	115183	nikkel matt	160	180	174
105604	115127	eloxált alumínium	160	180	174
106089	115182	nikkel matt	96	116	111
105522	115181	eloxált alumínium	96	116	111

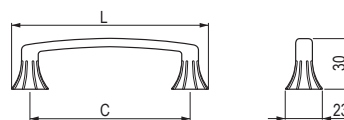
Salacia

kód	Hettich kód	felület	furattávolság C (mm)	L hossz (mm)
135768	9112591	cink	128	151



Vantania

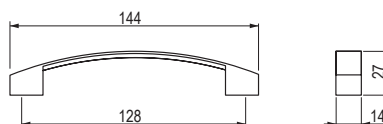

kód	Hettich kód	felület	furattávolság C (mm)	L hossz (mm)
134885	1170158	rozsdamentes acél imitáció	128	144
153735	9113211	króm fényes	128	144

Vigilia

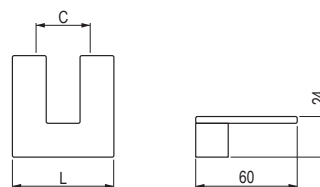

kód	Hettich kód	felület	furattávolság C (mm)	L hossz (mm)
106024	9065628	rozsdamentes acél imitáció	32	60

Genoa

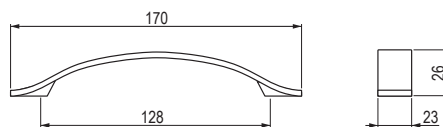

kód	Hettich kód	felület	furattávolság C (mm)	L hossz (mm)
106675	9065612	rozsdamentes acél imitáció	128	170

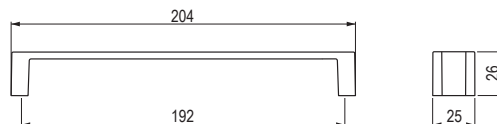
Intra

kód	Hettich kód	felület	furattávolság C (mm)	L hossz (mm)
153731	9105735	rozsdamentes acél imitáció/ króm matt	192	204
134824	9105737	króm matt/ króm matt	192	204

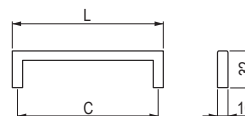
Anzio

kód	Hettich kód	felület	furattávolság C (mm)	L hossz (mm)
135134	1160020	csiszolt nemesacél	224	234
133349	1160022	csiszolt nemesacél	352	362
146742	1160023	csiszolt nemesacél	480	490

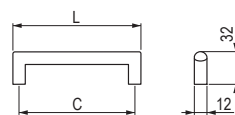
Narona

kód	Hettich kód	felület	furattávolság C (mm)	L hossz (mm)
166651	9070992	csiszolt nemesacél	192	204



Lamezia

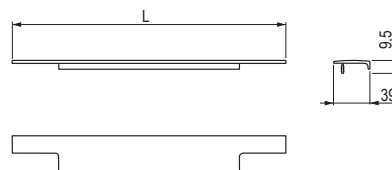
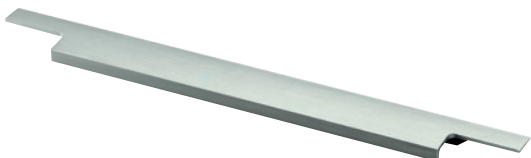

kód	Hettich kód	felület	L hossz (mm)
142098	9105815	rozsdamentes acél imitáció	295
130475	9105819	rozsdamentes acél imitáció	395
142099	9105820	rozsdamentes acél imitáció	445
130474	9105821	rozsdamentes acél imitáció	495
130473	9105822	rozsdamentes acél imitáció	595
130472	9105823	rozsdamentes acél imitáció	795
136073	9105824	rozsdamentes acél imitáció	895

Baldone

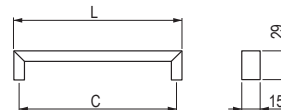
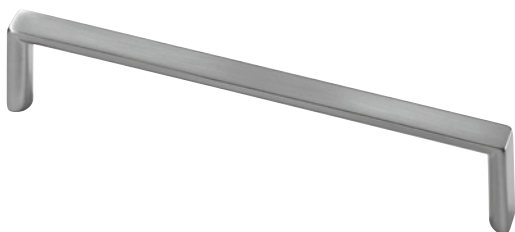

kód	Hettich kód	felület	furattávolság C (mm)	L hossz (mm)
135846	9995485	rozsdamentes acél imitáció	256	262

Chalcis

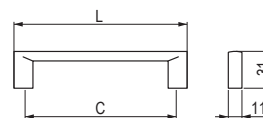

kód	Hettich kód	felület	furattávolság C (mm)	L hossz (mm)
161149	9113183	rozsdamentes acél imitáció	128	147
154385	9113182	rozsdamentes acél imitáció	288	301

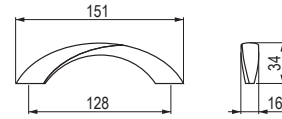
Coria

kód	Hettich kód	felület	furattávolság C (mm)	L hossz (mm)
154567	9112597	króm matt	128	151

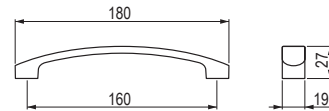
Salona

kód	Hettich kód	felület	furattávolság C (mm)	L hossz (mm)
141597	1170155	rozsdamentes acél imitáció	160	180

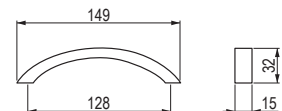
Balmo

kód	Hettich kód	felület	furattávolság C (mm)	L hossz (mm)
107814	43472	rozsdamentes acél imitáció	128	149



Haida

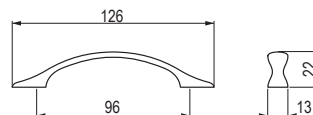

kód	Hettich kód	felület	furattávolság C (mm)	L hossz (mm)
156856	9113227	óarany	96	126

Empoli

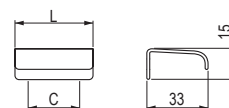

kód	Hettich kód	felület	furattávolság C (mm)	L hossz (mm)
131685	9995541	króm fényes	25	38
133474	9995540	króm matt	25	38
142100	9995542	rozsdamentes acél imitáció	25	38

Messana

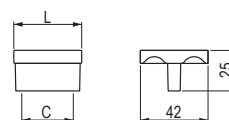
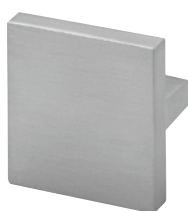

kód	Hettich kód	felület	furattávolság C (mm)	L hossz (mm)
107020	115156	rozsdamentes acél imitáció	32	42

Venusia

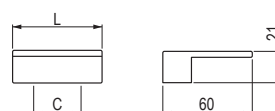

kód	Hettich kód	felület	furattávolság C (mm)	L hossz (mm)
105671	115154	rozsdamentes acél imitáció	32	60

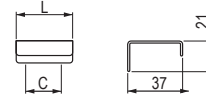
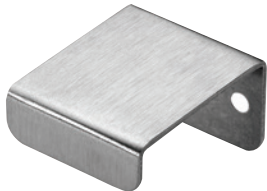
Narni

kód	Hettich kód	felület	furattávolság C (mm)	L hossz (mm)
134538	9995574	csiszolt nemesacél	20	30

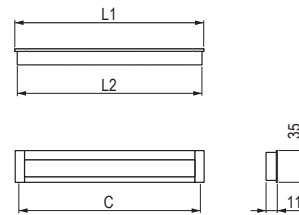
Nidum

kód	Hettich kód	felület	furattávolság C (mm)	L1 hossz (mm)	L2 hossz (mm)
106761	9071060	eloxált alumínium	96	111	107
105388	9071071	eloxált alumínium	128	143	139
107319	9071073	eloxált alumínium	160	175	171
106090	9071075	eloxált alumínium	192	207	203

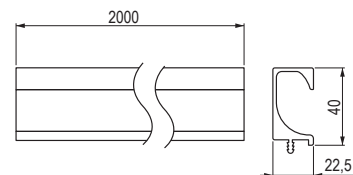
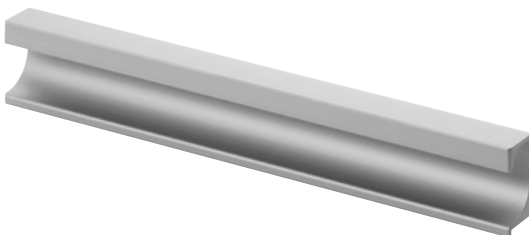
Eslinga

kód	Hettich kód	felület	L hossz (mm)
103797	115090	eloxált alumínium	2000



Spira

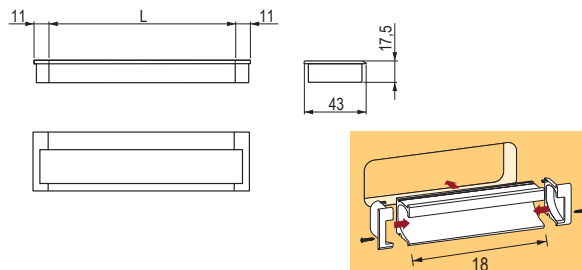

kód	Hettich kód	felület	L hossz (mm)
103806	115314	eloxált alumínium	2000
103805	115298	eloxált alumínium	2000

Aboa

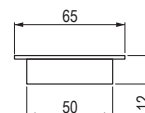

kód	Hettich kód	felület	belső átmérő (mm)	külső átmérő (mm)	H (mm)
106763	9070138	csiszolt nemesacél	50	65	2

Touch - in

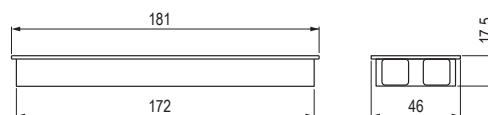

kód	Hettich kód	felület	L hossz (mm)
105901	9086687	rozsdamentes acél imitáció	181

Touch - in

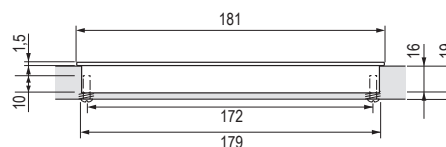

kód	Hettich kód	leírás	felület	L hossz (mm)
130326	9086695	takarósapka	nem lakkozott műanyag	181
127861	9086696	takarósapka	rozsdamentes acél imitáció	181
106193	9086691	fogantyú	rozsdamentes acél imitáció	181

- a felületkezelés nélküli takarósapka (ABS műanyag) lakkozáshoz készült
- a felületkezelt takarósapka furnér vagy hasonló anyag ragasztására

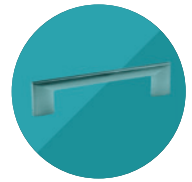

Adapter

a szétnyíló ajtókhöz alkalmas fogantyúk rögzítéséhez

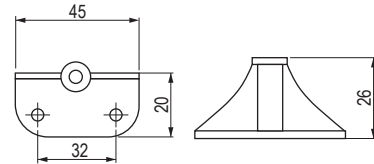

króm

289675

szatén nikkell

289676

Gumi alátét fogantyúhoz üvegre

üvegre való szereléshez



- szakszerű szereléshez használjon 2 db alátétet egy csavarhoz
- a fém nem érintkezhet közvetlenül az üveggel
- átlátszó, 4 mm átmérőjű csavaroknak

gumi alátét fogantyúhoz

08002

BlueJig jelölősablon fogantyúkhöz



- univerzális BLUEJIG sablon kéttengelyes beállítással a furatok helyzetének gyors és pontos megjelöléséhez
- 32 - 320 (mm) furattávolságú fogantyúkhöz készültek
- a fiók előlapjának oldalsó élétől a fogantyú első szerelési nyílása 10 - 334 (mm) távolságban lehet
- a fiók előlapjának felső élétől, ill. az előlap alsó élétől a fogantyúig 20 - 65 (mm) távolság lehet

jelölési sablonok

104215