



Katalog úchytek a věšáků

Handles and Hooks

2017



Dotek elegance pro každého /
A touch of elegance for everyone

tulip

Obsah / Contents



kovové úchytky / *metal handles*

1



knopky / *knobs*

47



zápustné úchytky / *recessed handles*

56

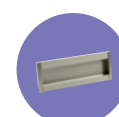

narážecí profily / *impact profiles*

63

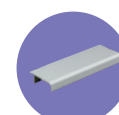

dvířkové a zásuvkové profily / *door and drawer profiles*

67

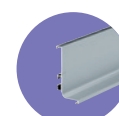

rustikální úchytky a knopky / *rustic handles and knobs*

73



porcelánové úchytky / *porcelain handles*

85



dřevěné úchytky / *wooden handles*

91



plastové úchytky / *plastic handles*

95



dětské úchytky / *baby handles*

100



věšáky / *hooks*

105

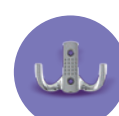

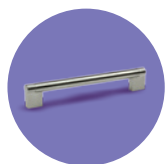

kovové úchytky / metal handles

ALMA

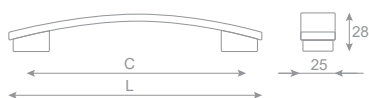

ČERNÝ NIKL LESK /
BLACK NICKEL POLISHED

C (mm) L (mm)

340588	160	183
340589	320	340

UMBERTO

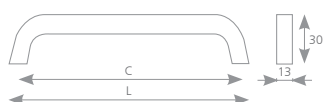

CHROM /
CHROME

IMITACE NEREZI /
ST. STEEL IMITATION

C (mm) L (mm)

192365	192369	192	214
192366	192370	256	278
192367	192371	320	345
192368	192372	448	470

ROMA



CHROM /
CHROME

IMITACE NEREZI /
ST. STEEL IMITATION

C (mm) L (mm)

192326	192327	192	246
192328	192329	288	346



SWOOSH



CHROM / CHROME	C (mm)	L (mm)	H (mm)
342275	128	150	29
340551	160	200	30
340584	320	360	32



BARI

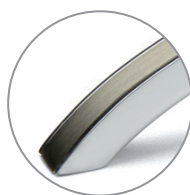

CHROM-IMIT. NEREZI / CHROME-ST. STEEL IMIT.	CHROM - BÍLÁ / CHROME - WHITE	CHROM - BR. CHROM / CHROME - BR. CHROME	C (mm)	L (mm)
192330	192333	192336	192	205
192331	192334	192337	320	334
192332	192335	192338	480	494

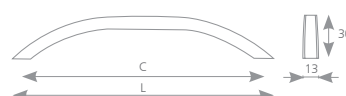

CRISTINA

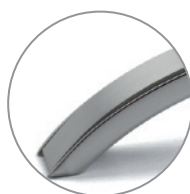

CHROM-IMIT. NEREZI / CHROME-ST. STEEL IMIT.	CHROM - BR. CHROM / CHROME - BR. CHROME	CHROM - BÍLÁ / CHROME - WHITE	C (mm)	L (mm)
192339	192343	192347	192	206
192340	192344	192348	320	334
192341	192345	192349	480	494
192342	192346	192350	672	686

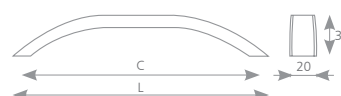

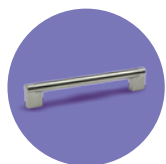

kovové úchytky / metal handles

BEATRICE

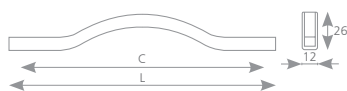
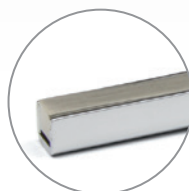

CHROM-IMIT. NEREZI / CHROME-ST. STEEL IMIT.	CHROM - BR. CHROM / CHROME - BR. CHROME	C (mm)	L (mm)
192351	192353	224	236
192352	192354	320	332

PECA

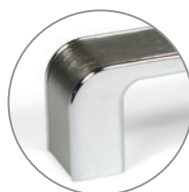

CHROM-IMIT. NEREZI / CHROME-ST. STEEL IMIT.	CHROM - HLINÍK / CHROME - ALUMINIUM	CHROM - BÍLÁ / CHROME - WHITE	C (mm)	L (mm)
225070	225067	227260	128	142
225071	225068	227261	192	206
225072	225069	225066	256	270

TACA



CHROM-IMIT. NEREZI / CHROME-ST. STEEL IMIT.	CHROM - HLINÍK / CHROME - ALUMINIUM	CHROM - BÍLÁ / CHROME - WHITE	C (mm)	L (mm)	H (mm)
246020	246016	246012	160	176	28
246021	246017	246013	256	272	30
246022	246018	246014	384	400	32



TACA

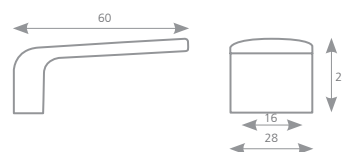
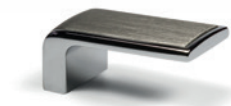

CHROM-IMIT. NEREZI / CHROME-ST. STEEL IMIT.	CHROM - HLINÍK / CHROME - ALUMINIUM	CHROM - BÍLÁ / CHROME - WHITE
246019	246015	246011

CUBIC



BÍLÁ / WHITE	ČERNÁ / BLACK	IMITACE NEREZI / ST. STEEL IMITATION	C (mm)	L (mm)
×	×	157571	128	148
157575	157576	157572	160	180
×	×	157573	192	212
×	×	157574	224	244
×	×	157570	12	27

MODENA

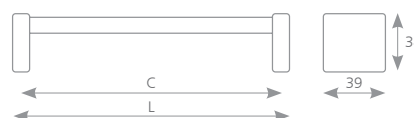

CHROM - HLINÍK / CHROME - ALUMINIUM	CHROM-IMIT. NEREZI / CHROME-ST. STEEL IMIT.	C (mm)	L (mm)
195143	195144	128	138
195145	195146	160	170
195147	195148	192	202
195149	195150	224	234
195151	195152	320	330
195153	195154	416	426
195155	195156	512	522
195157	195158	640	650
195159	195160	736	746

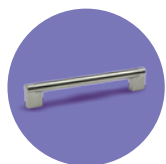

kovové úchytky / metal handles



VERONA

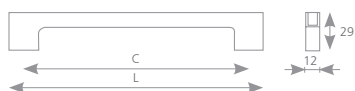
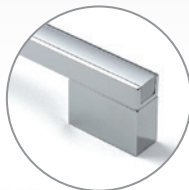

CHROM - HLINÍK / CHROME - ALUMINIUM	CHROM-IMIT. NEREZI / CHROME-ST. STEEL IMIT.	C (mm)	L (mm)
195116	195117	128	139
195119	195120	160	171
195122	195123	192	203
195125	195126	224	235
195128	195129	320	331
195131	195132	448	459
195134	195135	576	587
195137	195138	672	683
195140	195141	736	747

RAKA



NEREZ TMAVÁ KARTÁČOVANÁ /
DARK BRUSHED ST. STEEL

267243

ENUCA

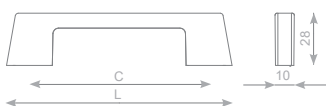
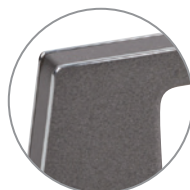

GRAFIT - CHROM / GRAPHITE - CHROME	C (mm)	L (mm)
284095	96	121
284096	128	143
284097	160	190
284098	224	254
284099	320	352



BUCATA



IMITACE NEREZI / ST. STEEL IMITATION	C (mm)	L (mm)
284224	128	140
284225	320	332

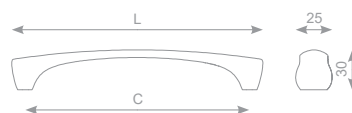

TARANA



CHROM / CHROME	C (mm)	L (mm)
284215	192	223
284216	320	351
284217	448	479

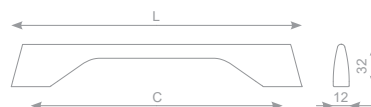

TINA



BROUŠENÝ NIKL / BRUSHED NICKEL	C (mm)	L (mm)	D (mm)	H (mm)
284226	128	215	13	25
284227	192	328	15	28

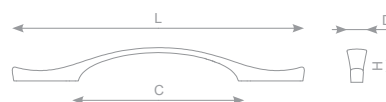

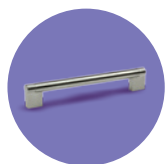

kovové úchytky / metal handles



ACARA



IMITACE NEREZI / ST. STEEL IMITATION	C (mm)	L (mm)
227217	160	168
227218	224	232
227219	320	328
227220	448	456
227221	544	552
227222	640	648

KOFU

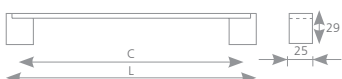

SATIN CHROM - HLINÍK / MATT CHROME - - ALUMINIUM ¹⁾	BROUŠENÝ NIKL / BRUSHED NICKEL	C (mm)	L (mm)
37850	37860	128	170
37851	37861	160	202
37852	37862	192	234
37853	37863	256	298
37854	37864	320	362
37855	37865	384	426
37856	37866	480	522
37857	37867	544	586
37858	37868	672	714
37859	37869	736	778

¹⁾ nožka satín chrom, tělo hliník / leg satín chrome, aluminum body

ENA



HLINÍK / ALUMINIUM	IMITACE NEREZI / ST. STEEL IMITATION	C (mm)	L (mm)
36910	36920	128	140
36911	36921	160	172
36912	36922	224	236
36913	36923	320	332
36914	36924	432	444
36915	36925	544	556
36916	×	672	684



PORTA



HLINÍK / ALUMINIUM	BROUŠENÝ NIKL / BRUSHED NICKEL	IMITACE NEREZI / ST. STEEL IMITATION	CHROM / CHROME	C (mm)	L (mm)
248014	37909	179439	157786	96	108
248015	37880	37980	157787	128	140
248016	37881	37981	157788	160	172
248017	37882	37982	157789	192	204
248018	37883	37983	157790	224	236
248019	37884	37984	157791	256	268
248020	37885	37985	157792	288	300
248021	37886	37986	157793	320	332
248022	37887	37987	157794	384	396
248023	37888	179441	157795	432	444
248024	37889	37989	157796	448	460
248025	37890	37990	157797	480	492
248026	37891	37991	157798	544	556
248027	37893	37993	157800	672	684
248028	37894	37994	157801	736	748
248029	37895	37995	157802	768	780
248030	x	x	x	832	844
248031	x	x	x	864	876
248032	x	x	x	960	972

NAGISA



STŘÍBRNÁ / SILVER	C (mm)	L (mm)
77912	96	115
77913	128	147
77914	160	179

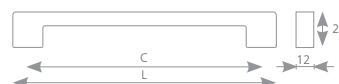

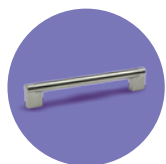

kovové úchytky / metal handles



TENGA



STŘÍBRNÁ / SILVER	IMITACE NEREZI / ST. STEEL IMITATION	C (mm)	L (mm)
77950	77951	160	179
77952	77953	320	344

FOKA

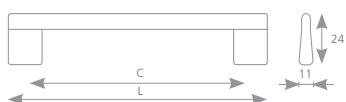

STŘÍBRNÁ / SILVER	IMITACE NEREZI / ST. STEEL IMITATION	C (mm)	L (mm)
77954	77955	160	189
77956	77957	320	349

JOSA

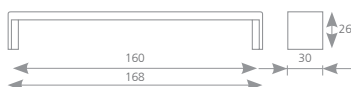
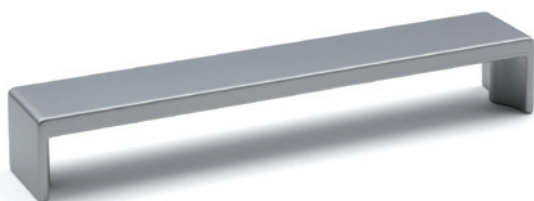

STŘÍBRNÁ / SILVER
77910



SOSA



SATIN CHROM / CHROME MATT	BROUŠENÝ NIKL / BRUSHED NICKEL	C (mm)	L (mm)	D (mm)	H (mm)
37031	37032	160	190	20	24
37033	37034	192	225	25	26



LACATA



IMITACE NEREZI / ST. STEEL IMITATION	HLINÍK / ALUMINIUM	C (mm)	L (mm)
227223	227230	128	138
227224	227231	160	170
227225	227232	224	234
227226	227233	320	330
227227	227234	448	458
227228	227235	544	554
227229	227237	640	650

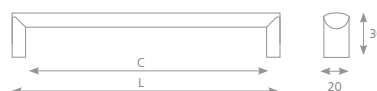

ROCATA

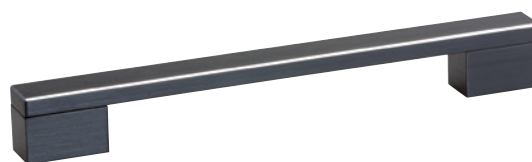

ČERNÁ / BLACK	C (mm)	L (mm)
284104	160	203
284105	224	267
284106	320	363
284107	480	523



věšák / hook ROCATA
(str. / pg. 108)



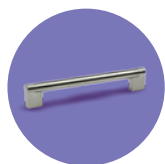

kovové úchytky / metal handles

LAURA

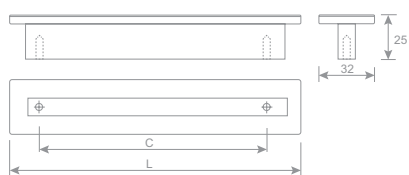
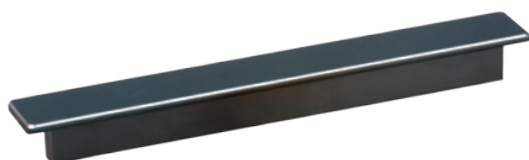

věšák / hook LAURA
(str. / pg. 108)

ČERNÁ / BLACK	C (mm)	L (mm)
320989	32	60
320991	128	168
320992	160	200
320993	224	264
320994	320	360
320995	448	488

KAMOTA

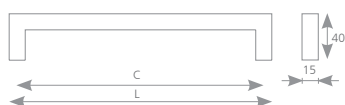

NEREZ / ST. STEEL	C (mm)	L (mm)
157717	160	175
157718	192	207
157719	256	271
157720	320	335

NAKANA

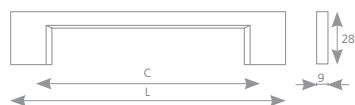

SATIN CHROM / CHROME MATT	BROUŠENÝ NIKL / BRUSHED NICKEL	CHROM / CHROME	C (mm)	L (mm)
37918	290750	202921	96	129
37919	290738	202922	128	161
303315	303316	303314	160	193
37920	290741	202923	192	225
290746	290744	202924	256	289
37922	290747	202925	320	353



DAVID

IMITACE NEREZI / ST. STEEL IMITATION	SATIN CHROM / MATT CHROME	C (mm)	L (mm)
10450	×	96	104
10451	×	128	136
10452	×	160	168
10453	10457	192	200
10454	10458	320	328
10455	10459	448	456

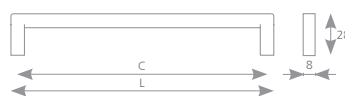

MARINA

NEREZ / ST. STEEL	C (mm)	L (mm)
203829	128	138
203822	160	170
203823	192	202
203824	224	234
203825	320	330
203826	480	490
203827	640	650
203828	736	746



SAKATA

NEREZ / ST. STEEL	C (mm)	L (mm)
157547	160	172
157548	192	204
157549	256	268
157550	320	332



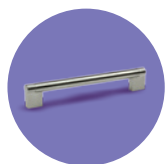

kovové úchytky / metal handles



OMONO

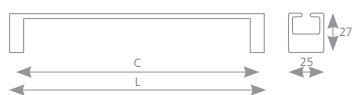

CHROM / CHROME	BROUŠENÝ NIKL / BRUSHED NICKEL	C (mm)	L (mm)
157187	157188	128	137
157185	157186	160	169
226972	226973	320	328

TOWADA



BROUŠENÝ NIKL / BRUSHED NICKEL	SATIN CHROM / CHROME MATT	C (mm)	L (mm)	D (mm)	H (mm)
157193	157196	128	143	25	22
157194	157197	160	175	22	32
157195	157198	224	239	22	32

MUTA

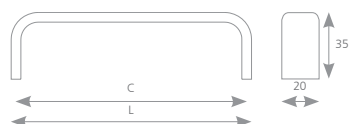

HLINÍK / ALUMINIUM	IMITACE NEREZI / ST. STEEL IMITATION	C (mm)	L (mm)
36821	36829	128	136
36822	36830	160	168
36823	36831	192	200
36824	36832	224	232
36825	36833	320	328
36826	36834	448	456
36827	36835	544	552



OGA



SATIN CHROM / CHROME MATT	BROUŠENÝ NIKL / BRUSHED NICKEL	C (mm)	L (mm)
157203	157199	96	102
157204	157200	128	134
157205	157201	160	166
157206	157202	192	198

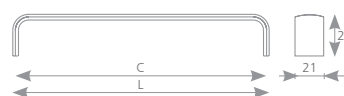

SCALA



HLINÍK / ALUMINIUM	IMITACE NEREZI / ST. STEEL IMITATION	C (mm)	L (mm)
227249	227240	160	179
227250	227242	192	211
227251	227243	224	243
227252	227244	320	339
227253	227245	448	467
227254	227246	544	563
227255	227247	640	659



MARCA



IMITACE NEREZI / ST. STEEL IMITATION	C (mm)	L (mm)
225008	160	197
225009	192	229
225010	224	261
225011	320	357
225012	448	485

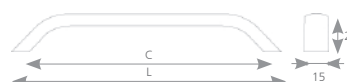

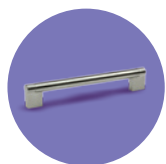

kovové úchytky / metal handles

ASAMA



SATIN CHROM / CHROME MATT	BROUŠENÝ NIKL / BRUSHED NICKEL	SATIN NIKL / NICKEL MATT	C (mm)	L (mm)	D (mm)	H (mm)
157231	157234	157228	160	204	17	26
157232	157235	157229	192	245	18	29
157233	157236	157230	288	366	20	31

ROMINA



CHROM / CHROME	IMITACE NEREZI / ST. STEEL IMITATION	C (mm)	L (mm)
202984	202989	192	212
202986	202990	256	276
202987	202991	320	340
202988	202992	448	468

ISA



MATNÝ BÍLÝ CHROME / MATT WHITE CHROME	C (mm)	L (mm)
37321	96	108
37322	128	140



AIRA

MATNÝ BÍLÝ CHROME / MATT WHITE CHROME	C (mm)	L (mm)	D (mm)	H (mm)
37301	96	105	17	28
37302	128	137	17	28
37311	128	140	24	32
37312	160	172	24	32
37313	320	332	24	32



DARA

SATIN CHROM / CHROME MATT
37751



MUSINA

SATIN CHROM / CHROME MATT	C (mm)	L (mm)	D (mm)
37101	64	82	13
37102	96	123	18

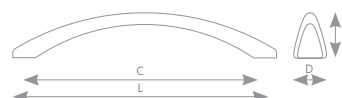

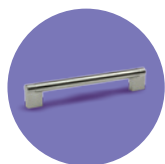

kovové úchytky / metal handles



SITA

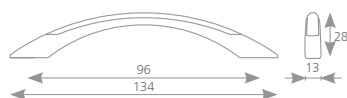

SATIN CHROM /
CHROME MATT

37131

EBINA

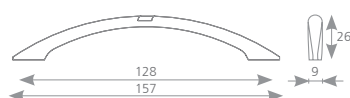

SATIN CHROM /
CHROME MATT

37091

ENOKA

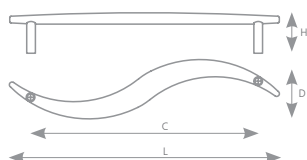

	C (mm)	L (mm)	D (mm)	H (mm)
CHROM-SATIN CHROM/ CHROM-SATIN CHROME				
37121	64	83	21	19
37122	96	124	36	22



RUSA



SATIN CHROM /
CHROME MATT

37111

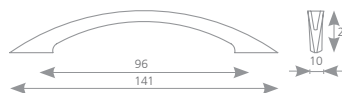

HRAZDA

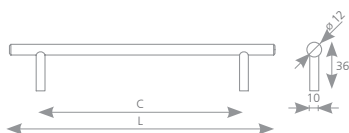

SATIN NIKL / NICKEL MATT	SATIN CHROM / MATT CHROME	CHROM / CHROME	BROUŠENÝ NIKL / BRUSHED NICKEL	HLINÍK / ALUMINIUM	DUTÁ NEREZ / HOLLOW ST. STEEL	C (mm)	L (mm)
35941	35942	35943	35947	202798	10640	96	136
35921	35922	35923	35927	202799	10641	128	168
35661	35662	35663	35667	202800	10642	160	200
36731	36732	36733	36737	202801	10643	192	232
35931	35932	35933	35937	202802	10644	224	264
36741	36742	36743	36747	202803	10645	288	328
35651	35652	35653	35657	202804	10646	320	360
x	x	x	x	x	10647	384	426
35951	35952	35953	35957	202805	10648	448	488
x	x	x	x	x	10649	512	554
35641	35642	35643	35647	202806	x	544	584
x	x	x	x	x	10650	576	618
x	x	x	x	x	10651	640	682
36751	36752	36753	36757	202807	10652	672	712
35961	35962	35963	35967	202808	10653	736	776
36761	36762	36763	36767	x	10654	768	808
36771	36772	36773	36777	x	10655	832	872
36781	36782	36783	36787	x	x	960	1000

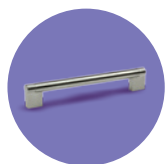

kovové úchytky / metal handles



PENKA

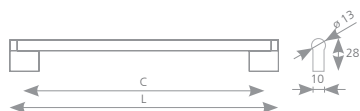

BROUŠENÝ NIKL / BRUSHED NICKEL	C (mm)	L (mm)
157249	96	104
157250	128	136
157251	160	168
157252	192	200
157253	224	232
157254	256	264
157255	320	328
157256	448	456
157257	560	568

LILA



IMITACE NEREZI / ST. STEEL IMITATION	HLINÍK / ALUMINIUM	CHROM / CHROME	BÍLÁ / WHITE	C (mm)	L (mm)
284109	284117	284125	284423	96	162
284110	284118	284126	284424	128	194
284111	284119	284127	284425	160	226
284112	284120	284128	284426	192	258
284113	284121	284129	284427	224	290
284114	284122	284130	284428	320	386
284115	284123	284131	284429	480	546
284960	284962	284964	284966	544	604
284116	284124	284132	284430	672	738



MORINA

MATNÝ BÍLÝ CHROME / MATT WHITE CHROME	C (mm)	L (mm)
37011	128	168
37012	160	200
157773	192	232
157774	256	296
37013	320	360
157775	384	424



RUMO

MATNÝ BÍLÝ CHROME / MATT WHITE CHROME	C (mm)	L (mm)
37021	128	176
37022	160	208

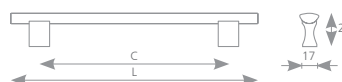

DALO

SATIN CHROM / CHROME MATT
36312

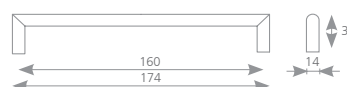

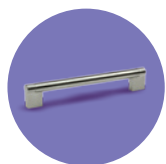

kovové úchytky / metal handles

MENUSA



HLINÍK /
ALUMINIUM

35971

LUCA



SATIN CHROM / CHROME MATT	IMITACE NEREZI / ST. STEEL IMITATION	C (mm)	L (mm)	D (mm)	H (mm)
224941	224945	128	141	21	22
224942	224946	160	172	21,5	23
224943	224947	224	235	21,5	23
224944	224948	256	267,5	20	22,5

ULICA



IMITACE NEREZI / ST. STEEL IMITATION	SATIN CHROM / CHROME MATT	C (mm)	L (mm)
289690	289696	128	146
289691	289697	160	178
289692	289698	192	210
289693	289699	256	274
289694	289700	320	338
289695	289701	416	434



RODOSO



SATIN CHROM /
CHROME MATT

37761



KAMINA



STŘÍBRNÁ /
SILVER

77936

IMITACE NEREZI /
ST. STEEL IMITATION

77939

C
(mm)

160

L
(mm)

191

H
(mm)

26



77937

77940

256

287

27

PAMIL



SATIN CHROM /
CHROME MATT

35822

BROUŠENÝ NIKL /
BRUSHED NICKEL

35827

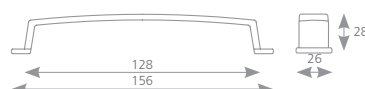

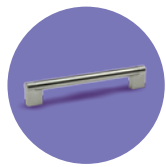

kovové úchytky / metal handles



SELENA



STŘÍBRNÁ / SILVER	IMITACE NEREZI / ST. STEEL IMITATION	C (mm)	L (mm)
77942	77943	160	216
77944	77945	256	341

ROTONDA

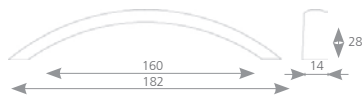

IMITACE NEREZI / ST. STEEL IMITATION	BÍLÁ / WHITE
227259	227258

PIEGATA

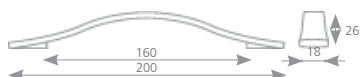

CHROM-IMIT. NEREZI / CHROME-ST. STEEL IMIT.	BÍLÁ / WHITE
227257	227256



MITIDA



SATIN CHROM /
CHROME MATT

37731



MARIBA



IMIT. NEREZI MAT /
ST. STEEL IMIT. MATT

267104

IMIT. NEREZI TMAVÁ BR. /
DARK BR. ST. STEEL IMIT.

267105



SEKOL



knopka / knob SEKOL
(str. / pg. 55)



ANTIK ENGLISH /
ANTIC ENGLISH

157270

C
(mm)

96

L
(mm)

156

157271

128

188

157272

160

230





kovové úchytky / metal handles

VERECA



IMITACE NEREZI / ST. STEEL IMITATION	C (mm)	L (mm)	H (mm)
284100	160	190	28
284101	224	266	28
284102	320	356	32,6
284103	480	550	32,6

MALADA

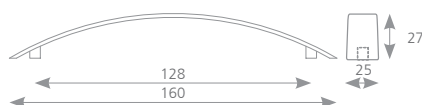
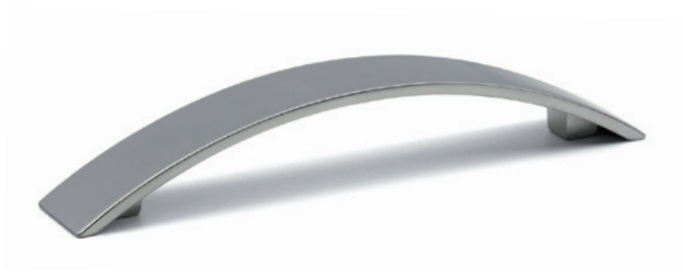

SATIN CHROM / CHROME MATT	BROUŠENÝ NIKL / BRUSHED NICKEL
35832	35837

FUKOL



SATIN CHROM / CHROME MATT
35432



KETA



SATIN NIKL /
NICKEL MATT

35131



LUDA



MOSAZ /
BRASS

289666

CHROM /
CHROME

289669

SATIN NIKL /
NICKEL MATT

289668

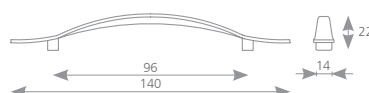

UNESA



SATIN CHROM /
CHROME MATT

157529

35412

157532

BROUŠENÝ NIKL /
BRUSHED NICKEL

157530

157531

157533

C
(mm)

L
(mm)

D
(mm)

H
(mm)

96

141

16

23

128

186

21

24

160

216

21

24

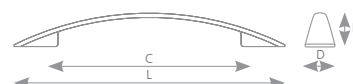

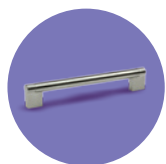

kovové úchytky / metal handles



ILUNA

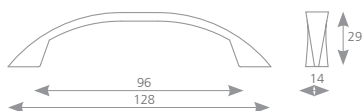

SATIN CHROM /
CHROME MATT

157527

BROUŠENÝ NIKL /
BRUSHED NICKEL

157528

SATIN NIKL /
NICKEL MATT

35301

PENETA

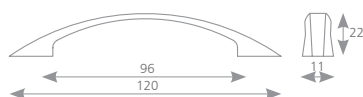

CHROM /
CHROME

289685

SATIN NIKL /
NICKEL MATT

289686

IBIKA

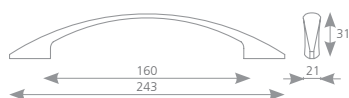

SATIN NIKL /
NICKEL MATT

35701



PALIN



SATIN NIKL / NICKEL MATT	CHROM / CHROME	MOSAZ / BRASS
35561	35563	35564

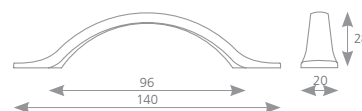

NOMINA



SATIN CHROM / CHROME MATT	SATIN NIKL / NICKEL MATT	CHROM / CHROME	C (mm)	L (mm)
157534	157535	×	96	108
35232	35231	35233	128	140

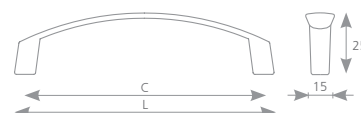

GENEDA



SATIN CHROM / CHROME MATT	BROUŠENÝ NIKL / BRUSHED NICKEL	C (mm)	L (mm)
35112	157537	96	108
157539	157540	128	140

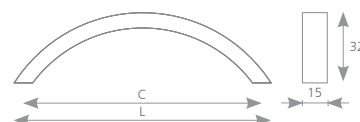

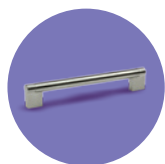

kovové úchytky / metal handles

SAKITA

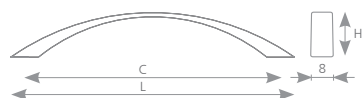

BROUŠENÝ NIKL / BRUSHED NICKEL	SATIN NIKL / NICKEL MATT	CHROM / CHROME	C (mm)	L (mm)	H (mm)
157556	157554	157555	96	116	25
157723	157721	157722	128	150	31

PELENA

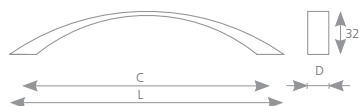

SATIN CHROM / CHROME MATT	BROUŠENÝ NIKL / BRUSHED NICKEL	C (mm)	L (mm)	D (mm)
157832	157824	96	106	18
157833	157825	128	140	19
157834	157826	160	174	20
37742	37741	192	228	20
157835	157827	224	257	20

VALI

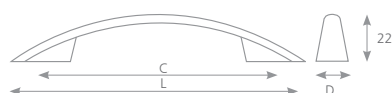

STAROMĚĎ / OLD COPPER	STAROCÍN / OLD TIN	C (mm)	L (mm)	D (mm)
226960	226963	96	140	15
226961	226964	128	174	16
226962	x	160	206	16



PIOMBINA

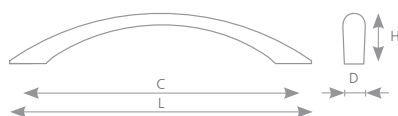

SATIN NIKL / NICKEL MATT	SATIN CHROM / CHROME MATT	CHROM / CHROME	MOSAZ / BRASS	ČERNÁ / BLACK	ČERNÝ NIKL / BLACK NICKEL	BR. NIKL / BR. NICKEL	STAROCÍN / OLD TIN	STAROMĚĎ / OLD COPPER	C (mm)	L (mm)	D (mm)	H (mm)
35251	35252	35253	35254	35255	35258	157520	226979	226980	96	127	12	24
35241	35242	x	x	35245	x	157521	226983	226981	128	164	14	28

ANITA



SATIN NIKL / NICKEL MATT	SATIN CHROM / CHROME MATT	CHROM / CHROME	MOSAZ / BRASS	ČERNÁ / BLACK	BÍLÁ / WHITE	ČERNÝ NIKL / BLACK NICKEL	BR. NIKL / BR. NICKEL	STAROCÍN / OLD TIN	STAROMĚĎ / OLD COPPER	C (mm)	L (mm)	D (mm)	H (mm)
35071	35072	35073	35074	35075	x	x	157524	x	x	64	81	9	23
35081	35082	35083	35084	35085	35089	35088	157525	226984	226985	96	115	10	28
35091	35092	35093	35094	35095	x	35098	157526	226988	226987	128	164	11	28

TIMINA



CHROM / CHROME	C (mm)	L (mm)	D (mm)	H (mm)
157709	96	123	9	21
157712	128	157	9	22
157715	160	190	10	25



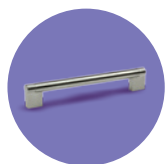

kovové úchytky / metal handles



UROSO



SATIN NIKL / NICKEL MATT	SATIN CHROM / CHROME MATT	CHROM / CHROME	C (mm)	L (mm)
35631	35632	35633	96	112
35141	35142	×	128	146

PRIMA

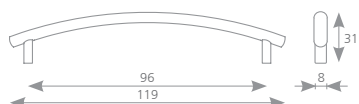

SATIN NIKL / NICKEL MATT	SATIN CHROM / CHROME MATT	CHROM / CHROME
35051	35052	35053

BESINA

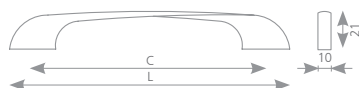

SATIN NIKL / NICKEL MATT	C (mm)	L (mm)
35471	96	121
35481	128	157
35491	160	190

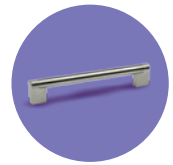

HALENA



SATIN NIKL / NICKEL MATT	SATIN CHROM / CHROME MATT	CHROM / CHROME
35291	35292	35293

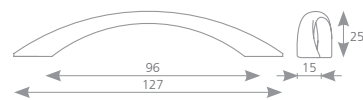

CEMUNA



SATIN NIKL / NICKEL MATT
35681



FIONA



SATIN NIKL / NICKEL MATT	SATIN CHROM / CHROME MATT	CHROM / CHROME
35041	35042	35043

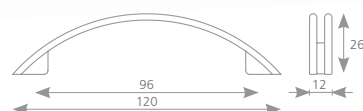

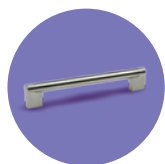

kovové úchytky / metal handles

BETA

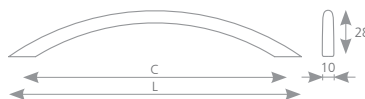

SATIN NIKL / NICKEL MATT	SATIN CHROM / CHROME MATT	CHROM / CHROME	MOSAZ / BRASS	ČERNÁ MATNÁ / BLACK MATT	BÍLÁ / WHITE	BR. NIKL / BR. NICKEL	C (mm)	L (mm)
35011	35012	35013	35014	35015	35019	35017	96	110
35021	35022	35023	×	35025	157522	157523	128	160

IDA

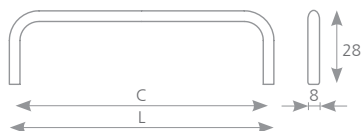

SATIN NIKL / NICKEL MATT	CHROM / CHROME	BROUŠENÝ NIKL / BRUSHED NICKEL	C (mm)	L (mm)
35341	157542	157543	96	104
157544	157545	157546	128	136
231423	231424	231422	160	170

KEWINA



SATIN NIKL / NICKEL MATT	SATIN CHROM / CHROME MATT	CHROM / CHROME	C (mm)	L (mm)	H (mm)
35161	35162	35163	96	124	25
35151	35152	35153	128	156	27



RUONA

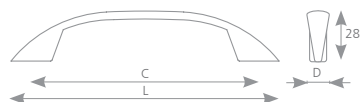

SATIN NIKL / NICKEL MATT	SATIN CHROM / CHROME MATT	CHROM / CHROME	MOSAZ / BRASS	ČERNÁ / BLACK	C (mm)	L (mm)	D (mm)
35451	35452	35453	35454	35455	96	132	15
35461	35462	35463	x	x	128	164	16

JAKOTO



MATNÝ BÍLÝ CHROME /
MATT WHITE CHROME

37051

HLINÍK /
ALUMINIUM

37053

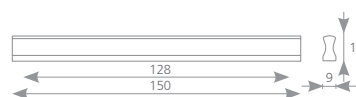

LIKANO



HLINÍK /
ALUMINIUM

36332

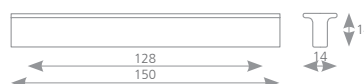

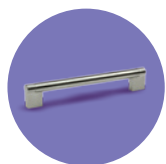

kovové úchytky / metal handles

WAKANO

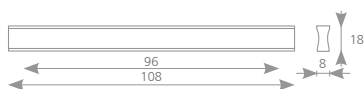

HLINÍK /
ALUMINIUM

36333

TALOMA

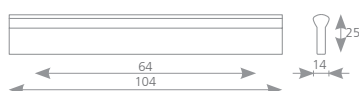

HLINÍK /
ALUMINIUM

37004

ZUZANA



HLINÍK /
ALUMINIUM

C
(mm)

L
(mm)

35900

32

44

35898

128

140

35899

360

372



PETARO

HLINÍK / ALUMINIUM	C (mm)	L (mm)
157519	96	108
36320	128	140
36321	160	172
36322	224	236
36323	360	372
36324	448	460

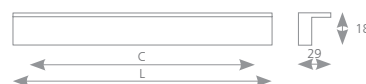

ISOLA

CHROM / CHROME	IMITACE NEREZI / ST. STEEL IMITATION	HLINÍK / ALUMINIUM	C (mm)	L (mm)
227293	227297	227301	96	116
227294	227298	227302	160	180
227295	227299	227303	224	244
227296	227300	227304	320	340



INCLINA

IMITACE NEREZI / ST. STEEL IMITATION	C (mm)	L (mm)
225062	96	116
225063	160	180
225064	224	244
225065	320	340

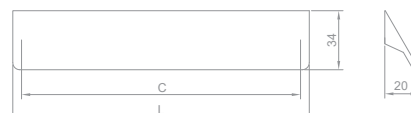

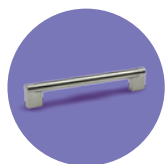

kovové úchytky / metal handles



ASUDA

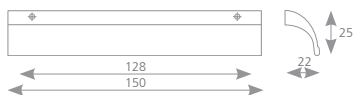

MATNÝ BÍLÝ CHROME /
MATT WHITE CHROME

37221

VOLENA

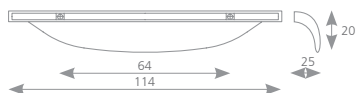

SATIN CHROM /
CHROME MATT

37241

MERITA

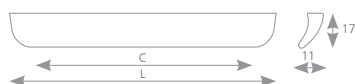

STŘÍBRNÁ /
SILVER

IMITACE NEREZI /
ST. STEEL IMITATION

C
(mm)

L
(mm)

77946

77947

160

178

77948

77949

256

338



FRANCESCA

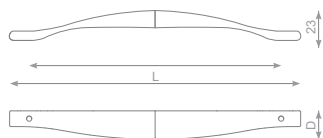

CHROM / CHROME	NIKL BROUŠENÝ / BRUSHED NICKEL	IMIT. NEREZI MAT / ST. STEEL IMIT. MATT	ANTRACIT LESKLÝ / POLISHED ANTHRACITE	ANTRACIT MAT / MATT ANTHRACITE	C (mm)	L (mm)	D (mm)
284994	284995	284996	284997	284998	160	185	22,5
284999	285000	285001	285002	285003	320	339	23,5

PATRIC



STŘÍBRNÁ / SILVER	H (mm)
77923	28
77924	50

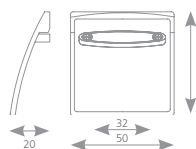

ZITO



STŘÍBRNÁ / SILVER
77925

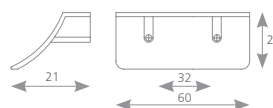

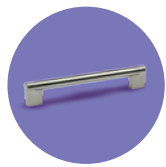

kovové úchytky / metal handles



KETINA

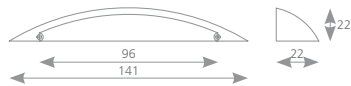

SATIN CHROM /
CHROME MATT

35872

LOKUTA



SATIN CHROM /
CHROME MATT

37172

SATIN NIKL /
NICKEL MATT

07756

KVADRA

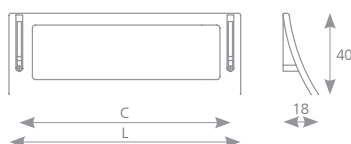

CHROM /
CHROME

77962

C
(mm)

32

L
(mm)

48

77960

160

175

77964

320

335



BELUGA



SATIN CHROM / CHROME MATT	IMITACE NEREZI / ST. STEEL IMITATION	C (mm)	L (mm)
×	42051	128	137
42052	42053	160	169
×	42055	224	233



PADOVA



IMITACE NEREZI / ST. STEEL IMITATION	C (mm)	L (mm)
157617	96	162
157618	224	290
157619	256	320

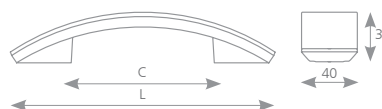

CORDOBA

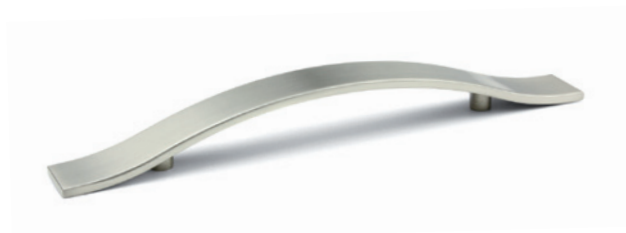

IMITACE NEREZI / ST. STEEL IMITATION	C (mm)	L (mm)
157609	160	257
157610	192	289
157611	192	321

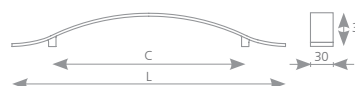

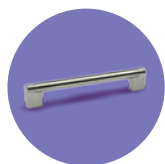

kovové úchytky / metal handles



RECIFE

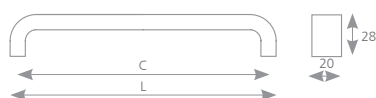

IMITACE NEREZI / ST. STEEL IMITATION	C (mm)	L (mm)
157638	128	137
157639	192	201
157640	224	233
157641	256	265
157642	320	329
157643	448	457

SANTIAGO



IMITACE NEREZI / ST. STEEL IMITATION	C (mm)	L (mm)
157658	64	72
157659	192	201

ELIPSE



IMITACE NEREZI / ST. STEEL IMITATION
42002



RIALTO



IMITACE NEREZI / ST. STEEL IMITATION	C (mm)	L (mm)
283962	160	241
283963	320	385

ARGUS

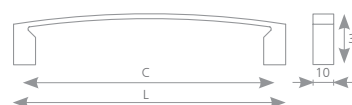

SATIN CHROM / MATT CHROME	IMITACE NEREZI / ST. STEEL IMITATION	C (mm)	L (mm)
42069	42070	96	110
42071	42072	128	140
42073	42074	160	173

ARGUS X

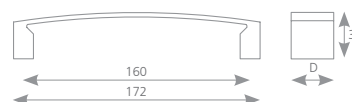

SATIN CHROM / CHROME MATT	IMITACE NEREZI / ST. STEEL IMITATION	D (mm)
42075	42076	25
42077	42078	35



kovové úchytky / metal handles

CARINA

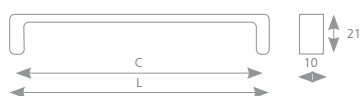

CHROM / CHROME	IMITACE NEREZI / ST. STEEL IMITATION	C (mm)	L (mm)
192361	192362	96	103
192363	192364	128	135

FERA



knopka / knob FERA
(str. / pg. 55)

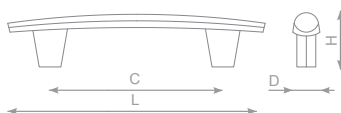

BROUŠENÁ OCEL / BRUSHED STEEL	C (mm)	L (mm)	D (mm)	H (mm)
284070	160	202	18	36
284071	256	300	18	36
284072	320	364	18	36
284073	448	492	21	39

RETA

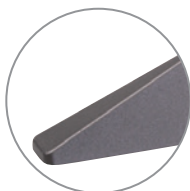

knopka / knob RETA
(str. / pg. 55)

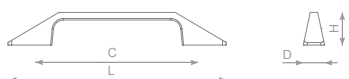

GRAFIT / GRAPHITE	IMITACE NEREZI / ST. STEEL IMITATION	C (mm)	L (mm)	D (mm)	H (mm)
284058	284064	96	156	17	25
284059	284065	128	174	17	26
284060	284066	160	211	18	27
284061	284067	256	311	20	28
284062	284068	320	377	20	28



ARCO

GRAFIT / GRAPHITE	IMITACE NEREZI / ST. STEEL IMITATION	C (mm)	L (mm)
284045	284049	128	248
284046	284050	160	272
284047	284051	256	340
284048	284052	320	410

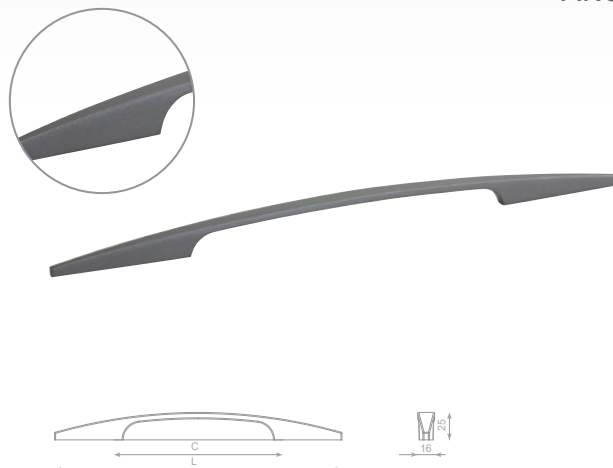

SEMA

TMAVÁ BROUŠENÁ / DARK BRUSHED	C (mm)	L (mm)	H (mm)
284053	128	181	27
284054	160	214	27
284055	256	309	29
284056	320	374	29

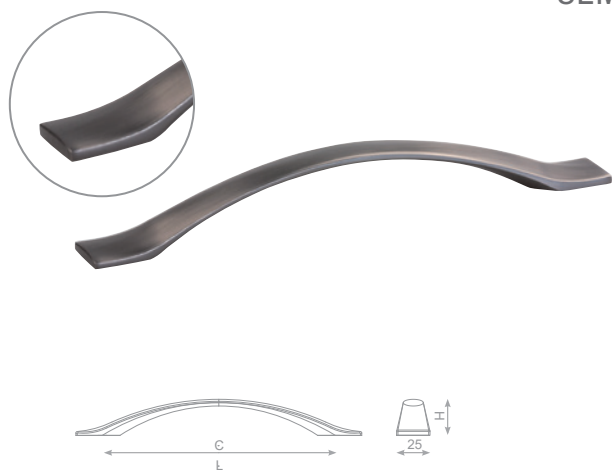

ZARA

OCEL BROUŠENÁ / BRUSHED STEEL	C (mm)	L (mm)	D (mm)	H (mm)
284041	128	170	12	27
284042	160	202	12	28
284043	256	298	13	29
284044	320	362	13	29



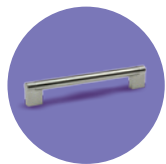

kovové úchytky / metal handles



DADA 100

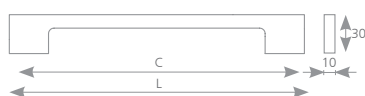
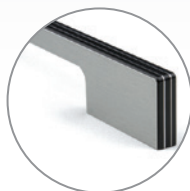

ČERNÁ MATNÁ / BLACK MATT	IMITACE NEREZI / ST. STEEL IMITATION	C (mm)	L (mm)
157489	157494	160	240
157490	157495	192	272
157491	157496	256	336
157492	157497	320	400
157493	157498	384	464

ENZA

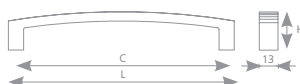

CHROM / CHROME	C (mm)	L (mm)	H (mm)
US004	96	107	22
US001	128	140	25

RUOTA

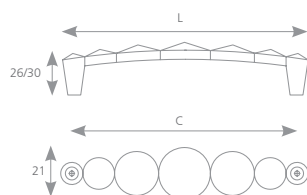

CHROM / CHROME	C (mm)	L (mm)
US008	32	48
US007	96	114
US006	128	145

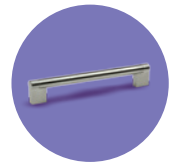

KUTTA



CHROM /
CHROME

US005

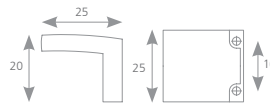

KUTTA



CHROM /
CHROME

US002

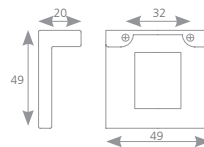

knopka / knob ENZA
(str. / pg. 47)

OSAKA



CHROM /
CHROME

US010

C (mm) L (mm) D (mm) H (mm)

US009

64 86 86 28

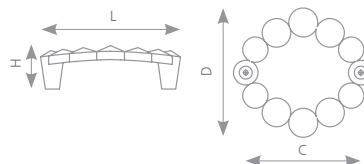

knopka / knob ROUTA
(str. / pg. 47)



knopky / knobs

RUOTA

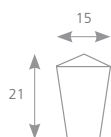

SATIN NIKL /
NICKEL MATT

US011

ENZA

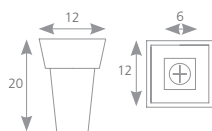

CHROM /
CHROME

US003

TOMIC

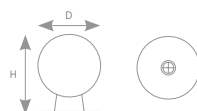

SATIN NIKL /
NICKEL MATT

SATIN CHROM /
CHROME MATT

CHROM /
CHROME

MOSAZ /
BRASS

D
(mm)

H
(mm)

35261

35262

35263

×

18

23

35271

35272

35273

35274

25

32



UKUDA



SATIN NIKL / NICKEL MATT	SATIN CHROM / CHROME MATT	CHROM / CHROME	BROUŠENÝ NIKL / BRUSHED NICKEL
157305	157306	157308	157307

RUZA

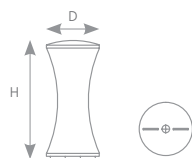

SATIN NIKL / SATIN NICKEL	SATIN CHROM / CHROME MATT	CHROM / CHROME	BROUŠENÝ NIKL / BRUSHED NICKEL	ČERNÝ / BLACK	D (mm)	H (mm)
157289	157290	157292	157291	157293	16	27
157294	157295	157297	157296	157299	21	35

JOTA



SATIN NIKL / SATIN NICKEL	SATIN CHROM / CHROME MATT	CHROM / CHROME	MOSAZ / BRASS	ČERNÁ / BLACK	BROUŠENÝ NIKL / BRUSHED NICKEL
35001	35002	35003	35004	35005	35007



knopky / knobs



GALKA

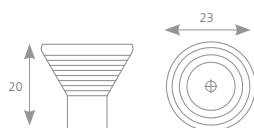

CHROM /
CHROME

SATIN CHROM /
CHROME MATT

289671

289672

IROKO



SATIN CHROM /
CHROME MATT

BROUŠENÝ NIKL /
BRUSHED NICKEL

37251

37252

RUDA



SATIN CHROM /
CHROME MATT

35892

TURIA

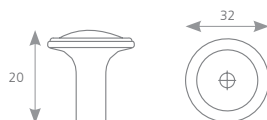

SATIN NIKL /
NICKEL MATT

SATIN CHROM /
CHROME MATT

BROUŠENÝ NIKL /
BRUSHED NICKEL

CHROM /
CHROME

STAROMOSAZ /
OLD BRASS EFFECT

157300

157301

157302

157303

157304



MARUSA



SATIN NIKL /
NICKEL MATT

35171

SATIN CHROM /
CHROME MATT

35172

CHROM /
CHROME

35173



MATEO

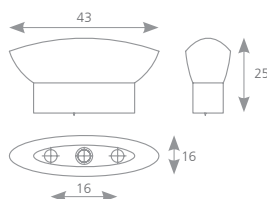

SATIN NIKL /
NICKEL MATT

35521

SATIN CHROM /
CHROME MATT

35522



PORESA

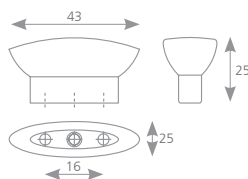

SATIN NIKL /
NICKEL MATT

35551

SATIN CHROM /
CHROME MATT

35552



SETAN

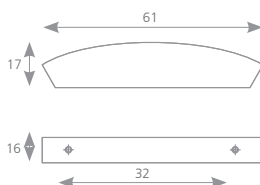

SATIN CHROM /
CHROME MATT

157238

CHROM /
CHROME

157239

BROUŠENÝ NIKL /
BRUSHED NICKEL

157240





knopky / knobs



RAPPA

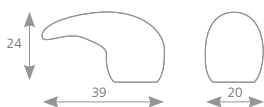

CHROM /
CHROME

35006

NODIE

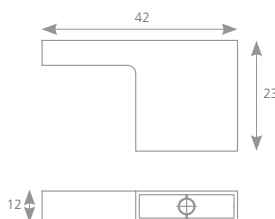

STŘÍBRNÁ /
SILVER

77916

TUCANA

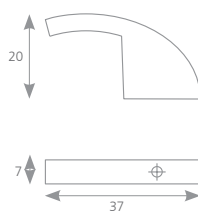
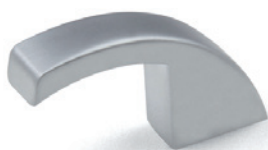

SATIN CHROM /
CHROME MATT

37162

LUNA

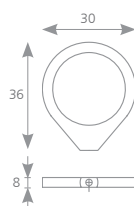

IMITACE NEREZI / ST.
STEEL IMITATION

42004



WHALE

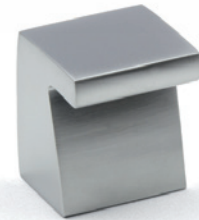

SATIN CHROM /
CHROME MATT

42029

IMITACE NEREZI /
ST. STEEL IMITATION

42030

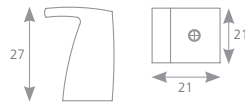

OTA



NEREZ /
STAINLESS STEEL

202884



ZOLA



SATIN CHROM /
CHROME MATT

37181

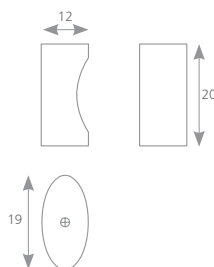

TINTO

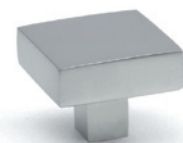

SATIN CHROM /
CHROME MATT

36313

CHROM /
CHROME

36314

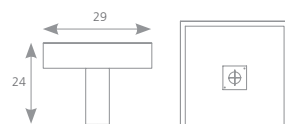



knopky / knobs



DADA 060

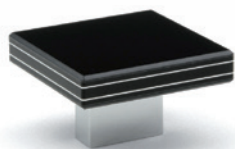

úchytka / handle DADA 100
(str. / pg. 45)



ČERNÁ MATNÁ /
BLACK MATT

IMITACE NEREZI /
ST. STEEL IMITATION

157500

157501

BLOCK



IMITACE NEREZI /
ST. STEEL IMITATION

42099

FRAME

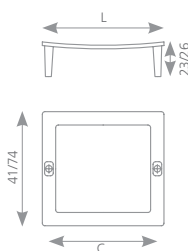

IMITACE NEREZI /
ST. STEEL IMITATION

C
(mm)

L
(mm)

42096

32

41

42095

64

74

PRISMA

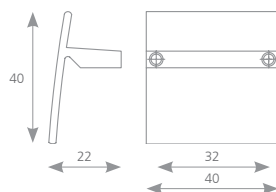
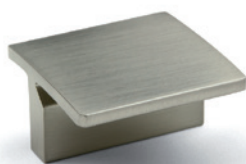

SATIN CHROM /
CHROME MATT

IMITACE NEREZI /
ST. STEEL IMITATION

42016

42017



VINTAGE S



SATIN CHROM /
CHROME MATT

157647

IMITACE NEREZI /
ST. STEEL IMITATION

157648

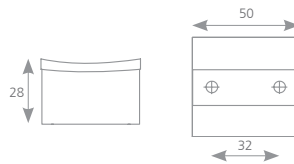

VINTAGE O



SATIN CHROM /
CHROME MATT

157649

IMITACE NEREZI /
ST. STEEL IMITATION

157651

BÍLÁ /
WHITE

157652

ČERNÁ /
BLACK

157653

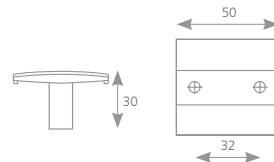

VINTAGE ST

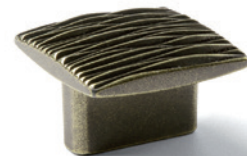

SATIN CHROM /
CHROME MATT

42083

PATINOVANÝ BRONZ

42084

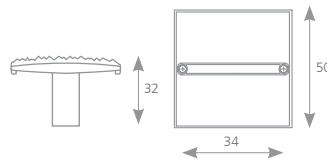

VINTAGE R



IMITACE NEREZI /
ST. STEEL IMITATION

157646

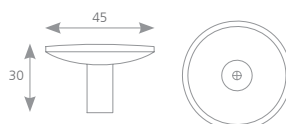



knopky / knobs

SEKOL

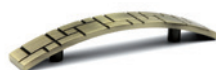

úchytko / handle SEKOL
(str. / pg. 24)

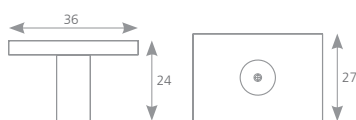

ANTIK ENGLISH /
ANTIC ENGLISH

157267

FERA



úchytko / handle FERA
(str. / pg. 43)



BROUŠENÁ OCEĽ /
BRUSHED STEEL

284069

RETA



úchytko / handle RETA
(str. / pg. 43)



GRAFIT /
GRAPHITE

IMITACE NEREŽI /
ST. STEEL IMITATION

284057

284063

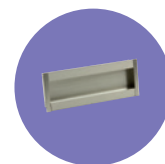

HELENA

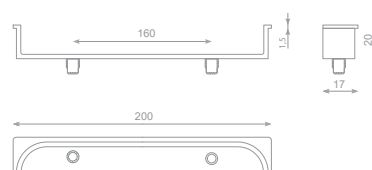

IMITACE NEREZI - LESK /
ST. STEEL IMITATION

283970

PISTA

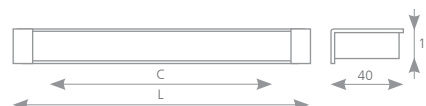
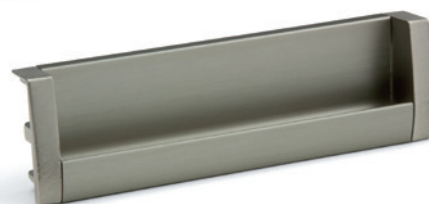

IMITACE NEREZI / ST. STEEL IMITATION	C (mm)	L (mm)	ROZMĚRY ZAHLOUBENÍ / MOUNTING SIZES (mm)
206136	128	143	137 × 38 × 14
206137	192	207	201 × 38 × 14
206138	320	335	329 × 38 × 14
206139	SAMOSTATNÝ PROFIL / PROFILE FOR HANDLE 1000 mm		
202853	KONCOVKA K PROFILU 206139 - LEVÁ / END CAP FOR HANDLE 206139 - LEFT		
202854	KONCOVKA K PROFILU 206139 - PRAVÁ / END CAP FOR HANDLE 206139 - RIGHT		

RAPID

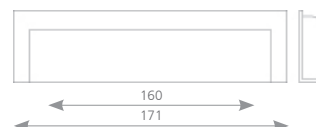

STŘÍBRNÁ /
SILVER

ROZMĚRY ZAHLOUBENÍ /
MOUNTING SIZE (mm)

215529

167 × 40 × 12,5

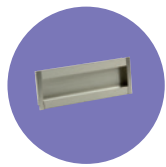

zápustné úchytky / recessed handles

ORINOCO



STŘÍBRNÁ / SILVER	C (mm)	L (mm)	ROZMĚRY ZAHLOUBENÍ / MOUNTING SIZE (mm)
157785	96	106	102 × 27 × 11
37201	128	138	134 × 27 × 11

MALUKA



HLINÍK / ALUMINIUM	IMITACE NEREZI / ST. STEEL IMITATION	C (mm)	L (mm)	ROZMĚRY ZAHLOUBENÍ / MOUNTING SIZE (mm)
157510	157514	128	143	138 × 42,3 × 14,2
157511	157515	160	175	170 × 42,3 × 14,2
157512	157516	192	207	202 × 42,3 × 14,2
157513	157517	256	271	266 × 42,3 × 14,2

NAVE

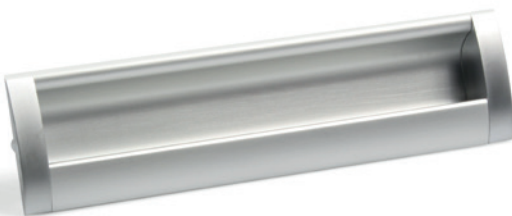

HLINÍK / ALUMINIUM	IMITACE NEREZI / ST. STEEL IMITATION	C (mm)	L (mm)	ROZMĚRY ZAHLOUBENÍ / MOUNTING SIZE (mm)
225013	225017	96	106	101 × 36 × 11
225014	225018	160	170	166 × 36 × 11
225015	225041	320	330	326 × 36 × 11
225016	225042	480	490	487 × 36 × 11

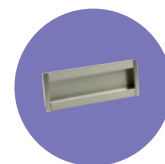

MALENA



Úchytka je vhodná na posuvné dveře tl. 18 mm /
Handle is suitable for sliding door th. 18 mm

HLINÍK / ALUMINIUM	IMITACE NEREZI / ST. STEEL IMITATION	C (mm)	L (mm)	ROZMĚRY ZAHLOUBENÍ / MOUNTING SIZE (mm)
226997	226999	96	104	98 × 38 × 9
226998	227000	192	215	209 × 38 × 9

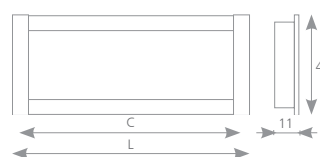
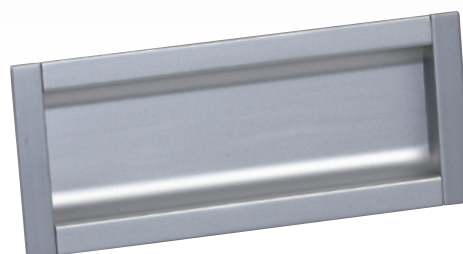

CONCAVA



MATNÝ BÍLÝ CHROME / MATT WHITE CHROME	SATIN CHROM / CHROME MATT	BROUŠENÝ NIKL / BRUSHED NICKEL	C (mm)	L (mm)	ROZMĚRY ZAHLOUBENÍ / MOUNTING SIZE (mm)
37331	37332	37333	96	109	103 × 36 × 14
157776	157777	157778	128	140	137 × 36 × 14
37191	37192	37193	160	171	167 × 36 × 14

COMOLA



SATIN CHROM / CHROME MATT	C (mm)	L (mm)	ROZMĚRY ZAHLOUBENÍ / MOUNTING SIZE (mm)
205123	192	216	211 × 35 × 14

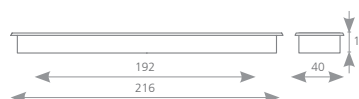

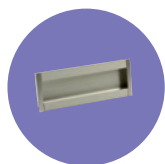

zápustné úchytky / recessed handles

RULIDA



STŘÍBRNÁ / SILVER	C (mm)	L (mm)	ROZMĚRY ZAHLOUBENÍ / MOUNTING SIZE (mm)
37006	128	145	136 × 33 × 14
37007	256	278	267 × 33 × 14
37008	320	337	327 × 33 × 14
37009	544	561	556 × 33 × 14

SWIFT

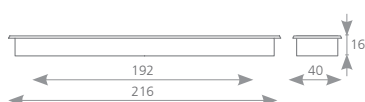

IMITACE NEREZI / ST. STEEL IMITATION	TMAVÝ BRONZ / DARK BRONZE	ROZMĚRY ZAHLOUBENÍ / MOUNTING SIZE (mm)
42112	157579	211 × 35 × 14

ILITA

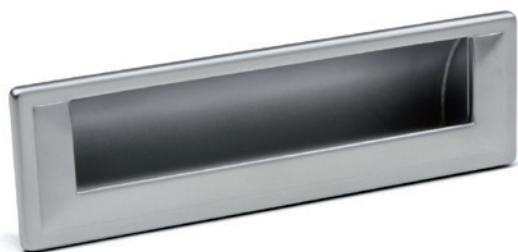

SATIN CHROM / CHROME MATT	ROZMĚRY ZAHLOUBENÍ / MOUNTING SIZE (mm)
289670	140 × 38 × 14

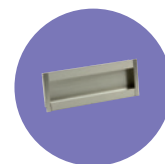

PESARA



BROUŠENÝ NIKL / BRUSHED NICKEL	SATIN CHROM / CHROME MATT	SATIN NIKL / NICKEL MATT	C (mm)	L (mm)	ROZMĚRY ZAHLOUBENÍ / MOUNTING SIZE (mm)
157782	157783	157784	96	107	102 × 28 × 10
157781	37781	37783	128	139	135 × 28 × 10

CESARO

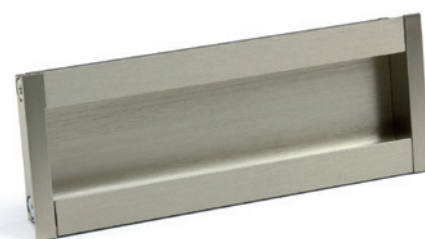
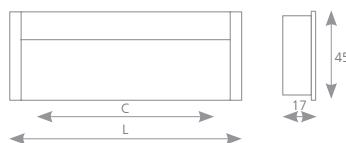

CHROM BROUŠENÝ / BRUSCHED CHROME	CHROM / CHROME	IMITACE NEREZI / ST. STEEL IMITATION	C (mm)	L (mm)	ROZMĚRY ZAHLOUBENÍ / MOUNTING SIZE (mm)
192355	192356	192357	96	119	114,5 × 40 × 15
192358	192359	192360	160	183	168,5 × 40 × 15
×	×	203961	320	343	328,5 × 40 × 15
×	×	203964	480	503	488,5 × 40 × 15

ANETTA

STŘÍBRNÁ / SILVER	C (mm)	L (mm)	ROZMĚRY ZAHLOUBENÍ / MOUNTING SIZE (mm)
37870	96	120	114 × 57,5 × 14,5
37871	128	150	148 × 57,5 × 14,5
37872	160	190	184 × 57,5 × 14,5
37873	192	246	240 × 57,5 × 14,5
37874	224	270	264 × 57,5 × 14,5
37875	256	296	290 × 57,5 × 14,5
37877	480	600	514 × 57,5 × 14,5
37878	672	712	706 × 57,5 × 14,5



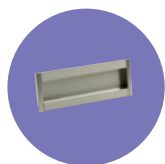

zápustné úchytky / recessed handles

MADRID



STŘÍBRNÁ /
SILVER

ROZMĚRY ZAHLOUBENÍ /
MOUNTING SIZE (mm)

36334

142,6 × 30 × 12

UTARA

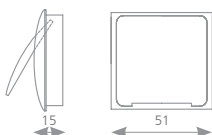

BROUŠENÝ NIKL /
BRUSHED NICKEL

SATIN CHROM /
SATIN CHROME

ROZMĚRY ZAHLOUBENÍ /
MOUNTING SIZE (mm)

37261

37262

46 × 46 × 10,2

PORTOS

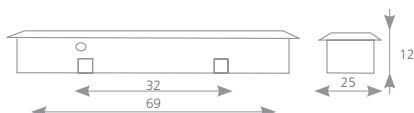

SATIN CHROM /
CHROME MATT

ROZMĚRY ZAHLOUBENÍ /
MOUNTING SIZE (mm)

226935

64 × 19 × 10

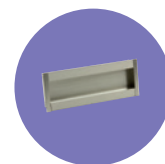

MANE



STŘÍBRNÁ /
SILVER

77823

ROZMĚRY ZAHLOUBENÍ /
MOUNTING SIZE (mm)

63,2 × 63,2 × 13

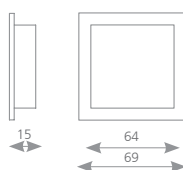

AVOCA



SATIN CHROM /
CHROME MATT

37771

SATIN NIKL /
NICKEL MATT

37773

BROUŠENÝ NIKL /
BRUSHED NICKEL

15779

ROZMĚRY ZAHLOUBENÍ /
MOUNTING SIZE (mm)

82 × 26,5 × 9

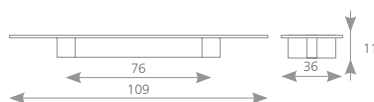

KANIVA

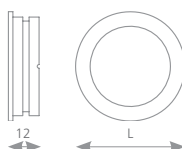

SATIN NIKL /
NICKEL MATT

35531

SATIN CHROM /
CHROME MATT

35532

CHROM /
CHROME

35533

L
(mm)

40

ROZMĚRY ZAHLOUBENÍ /
MOUNTING SIZE (mm)

35 × 35 × 10

35541

35542

35543

50

42 × 42 × 10

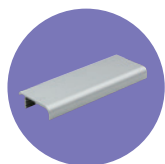

narážecí profily / impact profiles

TEPPO

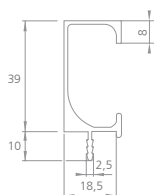
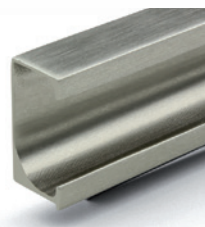

IMITACE NEREZI / ST. STEEL IMITATION	HLINÍK / ALUMINIUM	L (mm)
205113	×	297
205114	×	347
205115	×	397
205116	×	447
205117	×	497
205118	×	597
205119	×	797
205120	×	897
205121	×	997
205122	×	1197
264488	×	1500
×	202875	3000

PAOLO

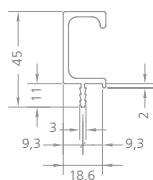
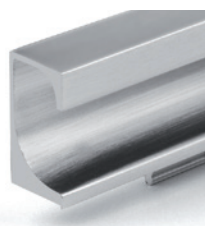

HLINÍK / ALUMINIUM	IMITACE NEREZI / ST. STEEL IMITATION II	L (mm)
215266	×	297
215267	×	347
215268	×	397
215269	×	447
215270	×	497
215271	×	597
215272	×	797
215273	×	897
215274	×	997
215275	×	1197
276820	276821	3000

JUVIO

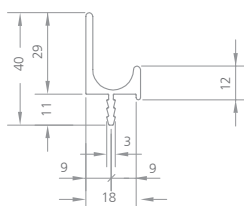
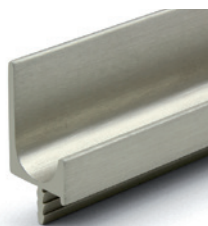

IMITACE NEREZI / ST. STEEL IMITATION	L (mm)
202858	297
202859	347
202860	397
202861	447
202862	497
202863	597
202864	797
202865	897
202866	997
202867	1197
264487	1500

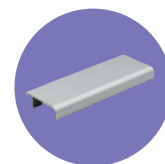

JUVIO

HLINÍK / ALUMINIUM	IMITACE NEREZI / ST. STEEL IMITATION II	L (mm)
276815	276814	3000

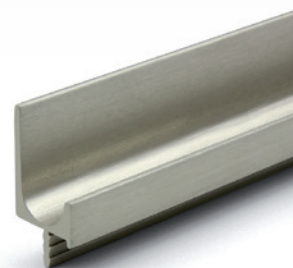
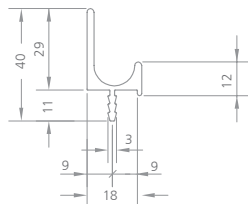

MARITTA

HLINÍK / ALUMINIUM	IMITACE NEREZI / ST. STEEL IMITATION II	L (mm)
276816	276817	3000

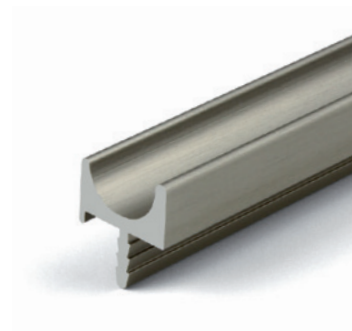
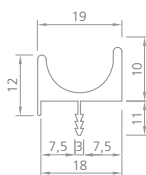

RIANNA

HLINÍK / ALUMINIUM	IMITACE NEREZI / ST. STEEL IMITATION II	L (mm)
276818	276819	3000

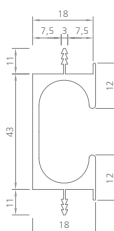

FANO

HLINÍK / ALUMINIUM	L (mm)
UC001	2450

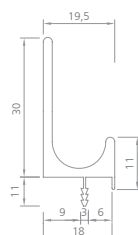

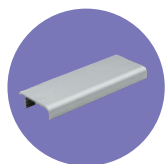

narážecí profily / impact profiles

PIANO

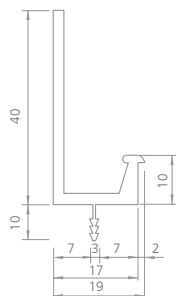
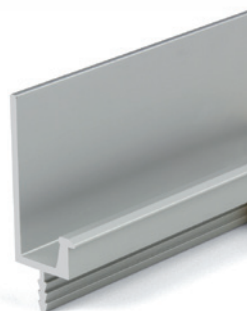

HLINÍK /
ALUMINIUM L
(mm)

UC002 2450

FLATA

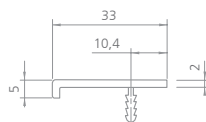

CHROM /
CHROME L
(mm)

36358 70

36362 348

169436 478

36366 688

169438 778

LUNGO

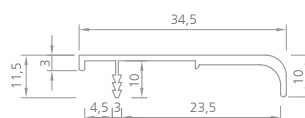
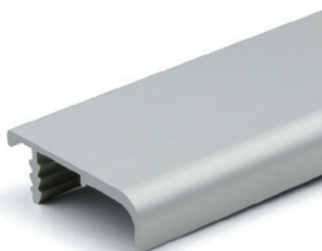

HLINÍK /
ALUMINIUM L
(mm)

UC004 2950

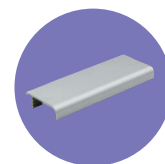

IMITACE NEREZI / ST. STEEL IMITATION	HLINÍK / ALUMINIUM	L (mm)
244831	244834	146
244832	244835	196
202816	244836	296
202817	244837	346
244833	244838	396
202818	244839	446
202819	244840	496
202820	244841	596
202821	244842	796
202822	244843	896
202823	244844	996
202824	244845	1196
x	284333	3000 ¹⁾

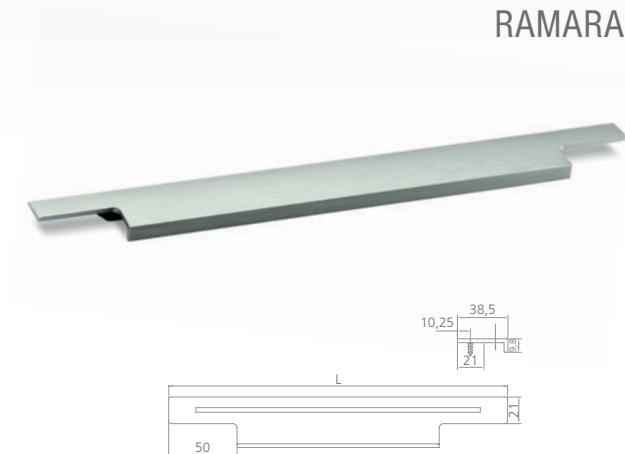

RAMARA

¹⁾verze o délce 3 metry je profil bez ořezování konců /
3m-profile has no cutting ends

IMITACE NEREZI / ST. STEEL IMITATION	L (mm)
320969	146
320971	196
320974	296
320975	346
320976	396
320977	446
320978	496
320980	596
320981	696
320983	796
320984	896
320985	996
320986	1196



SOPHIA



Narážecí profily v katalogu jsou z různých výrobních závodů, doporučujeme kombinovat totožné povrchové úpravy (=stejný index barvy).

Buffing profiles are from different producers, we recommend to combine the identical color index.

CHROM / CHROME	IMITACE NEREZI / ST. STEEL IMITATION	HLINÍK / ALUMINIUM	C (mm)	L (mm)
227265	227271	227276	32	52
227266	227272	227277	64	84
227267	227273	227278	96	116
227269	227274	227279	160	180
227270	227275	227280	320	340
x	x	284334	-	3000

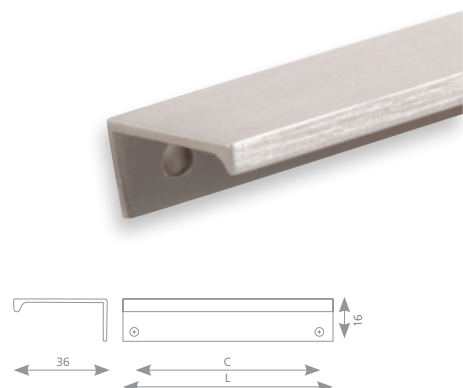

LUCATA

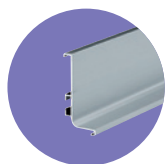

dvířkové a zásuvkové profily / door and drawer profiles

GOLA SYSTÉM / GOLA SYSTEM

- Systém pro bezúchytkové otevírání dveří. Zahrnuje profily horizontální (vešměs pro použití v kuchyni) a vertikální (šatní skříně).
- A system for handle-less door opening. Horizontal profiles (mostly for use in the kitchen) and vertical profiles (for wardrobes) are included.



horizontální dvířkový "J" profil / horizontal door profile 'J'

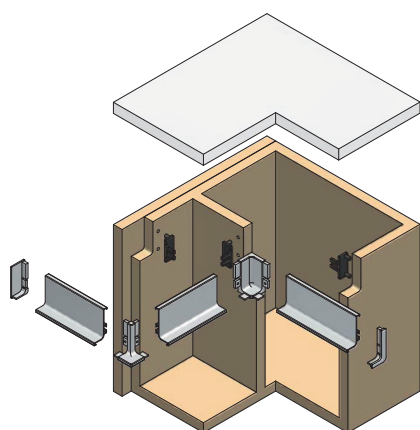

horizontální zásuvkový "C" profil / horizontal drawer profile 'C'

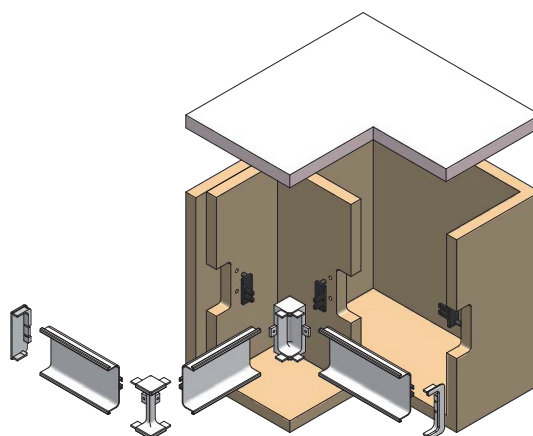

Vertikální profily (boční a středový) / vertical profiles (side and central)

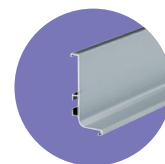

HORIZONTÁLNÍ PROFILY GOLA / HORIZONTAL PROFILE GOLA

DVÍŘKOVÝ J PROFIL / DOOR J PROFILE 4.1 m

profil pod pracovní desku / under the worktop

228304	IMITACE NEREZI / ST. STEEL IMITATION
151631	HLINÍK / ALUMINIUM
284149	BÍLÁ / WHITE

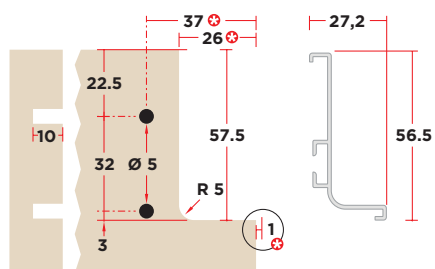

- uvedené montážní rozměry platí pro případ že profil bude přesahovat 1 mm
- pokud chcete mít profil zapuštěn v rovině, navýšte je o 1 (37->38, 26->27)
- the mounting dimensions are valid for 1mm exceeding
- if you want a profile embedded in the board, add 1 mm (37-> 38, 26-> 27)

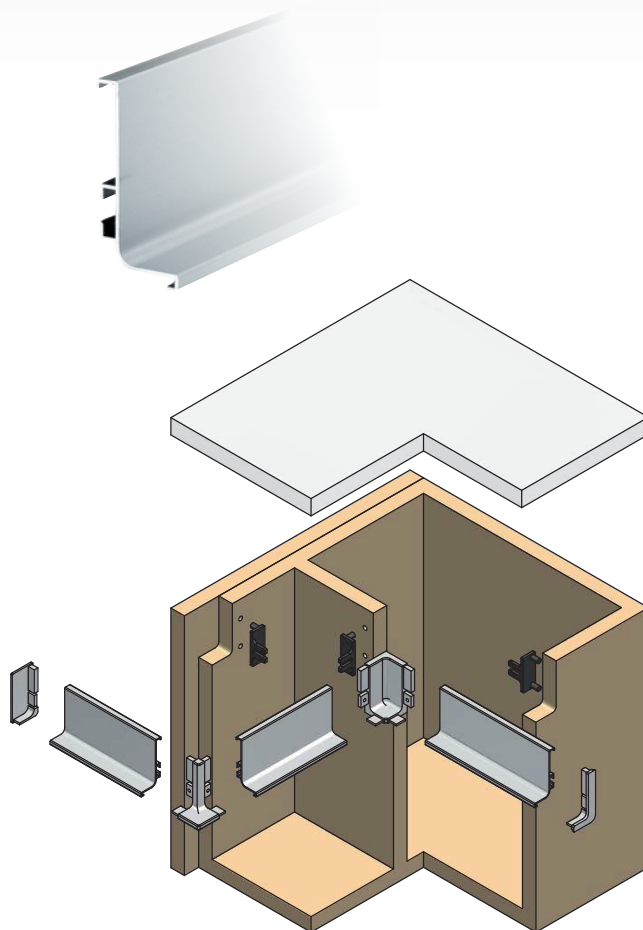

OTEVŘENÁ KONCOVKA DVÍŘKOVÉHO PROFILU / OPEN ENDING OF DOOR PROFILE

228305	IMITACE NEREZI / ST. STEEL IMITATION
151632	HLINÍK / ALUMINIUM
232861	PLAST STŘÍBRNÝ / SILVER PLASTIC
289124	BÍLÁ / WHITE

- sada P+L koncovka
- kit R+L ending

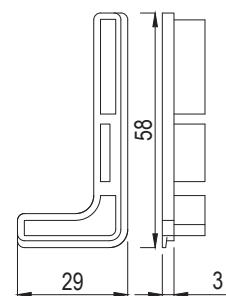

UZAVŘENÁ KONCOVKA DVÍŘKOVÉHO PROFILU / CLOSED ENDING OF DOOR PROFILE

284150	IMITACE NEREZI / ST. STEEL IMITATION
284151	HLINÍK / ALUMINIUM
284152	PLAST STŘÍBRNÝ / SILVER PLASTIC
289121	BÍLÁ / WHITE

- sada P+L koncovka
- kit R+L ending

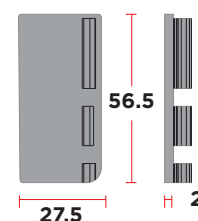

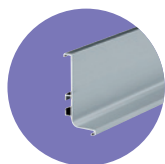

dvířkové a zásuvkové profily / door and drawer profiles

VNĚJŠÍ ROH DVÍŘKOVÉHO PROFILU / OUTER CORNER OF DOOR PROFILE

228306	IMITACE NEREZI / ST. STEEL IMITATION
151717	HLINÍK / ALUMINIUM
284153	BÍLÁ / WHITE

- materiál: hliník
- material: aluminium

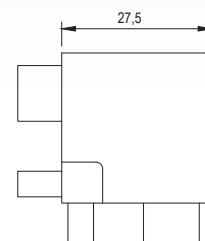

VNITŘNÍ ROH DVÍŘKOVÉHO PROFILU / INNER CORNER OF DOOR PROFILE

228307	IMITACE NEREZI / ST. STEEL IMITATION
151718	HLINÍK / ALUMINIUM
284154	BÍLÁ / WHITE

- materiál: hliník
- material: aluminium

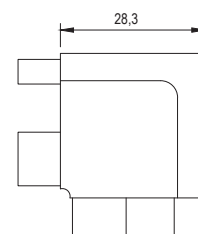

ZÁSUVKOVÝ C PROFIL / DRAWER PROFILE C 4,1 m

- profil pro použití mezi zásuvkami nad sebou
- profile for using between the drawers

228308	IMITACE NEREZI / ST. STEEL IMITATION
151732	HLINÍK / ALUMINIUM
284155	BÍLÁ / WHITE

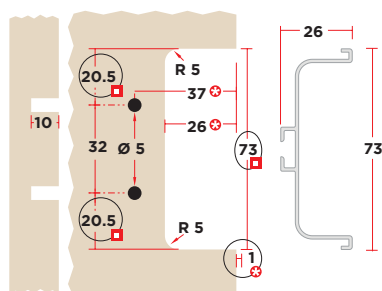

- uvedené montážní rozměry platí pro případ že profil bude přesahovat 1mm
- pokud chcete mít profil zapuštěn v rovině, navyšte je o 1 (37->38, 26->27)
- the mounting dimensions are valid for 1mm exceeding
- if you want a profile embedded in the board, add 1 mm (37-> 38, 26-> 27)

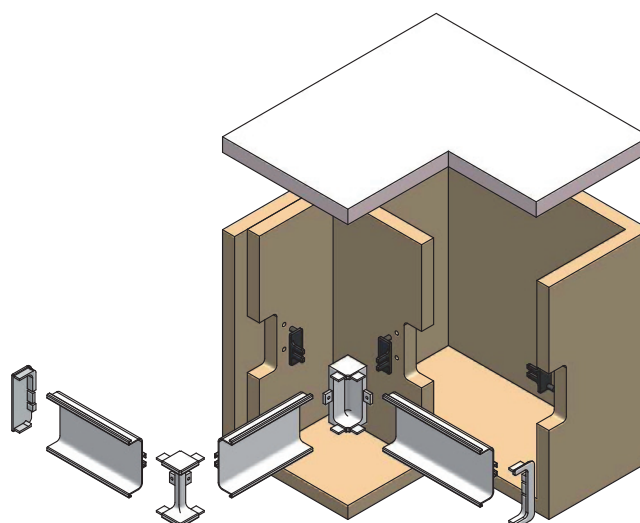

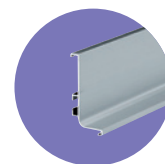

OTEVŘENÁ KONCOVKA ZÁSUVKOVÉHO PROFILU / OPEN ENDING OF DRAWER PROFILE

228309	IMITACE NEREZI / ST. STEEL IMITATION
151785	HLINÍK / ALUMINIUM
232862	PLAST STŘÍBRNÝ / SILVER PLASTIC
289123	BÍLÁ / WHITE

- sada P+L koncovka
- používá se jen, pokud profil není mezi boky skříňky
- *kit R + L ending*
- *do not use if the profile is between the cabinet sides*

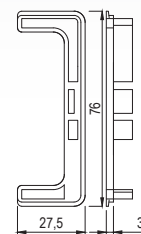

UZAVŘENÁ KONCOVKA ZÁSUVKOVÉHO PROFILU / CLOSED ENDING OF DRAWER PROFILE

284156	IMITACE NEREZI / ST. STEEL IMITATION
284157	HLINÍK / ALUMINIUM
284158	PLAST STŘÍBRNÝ / SILVER PLASTIC
289122	BÍLÁ / WHITE

- sada P+L koncovka
- používá se jen, pokud profil není mezi boky skříňky
- *kit R+L ending*
- *do not use if the profile is between the cabinet sides*

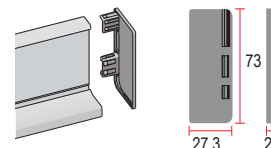

VNĚJŠÍ ROH ZÁSUVKOVÉHO PROFILU / OUTER CORNER OF DRAWER PROFILE

228310	IMITACE NEREZI / ST. STEEL IMITATION
151786	HLINÍK / ALUMINIUM
284159	BÍLÁ / WHITE

- materiál: hliník
- *material: aluminium*

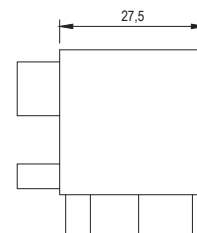

VNITŘNÍ ROH ZÁSUVKOVÉHO PROFILU / INNER CORNER OF DRAWER PROFILE

228311	IMITACE NEREZI / ST. STEEL IMITATION
151821	HLINÍK / ALUMINIUM
284160	BÍLÁ / WHITE

- materiál: hliník
- *material: aluminium*

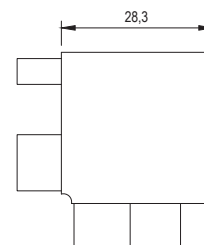

PŘÍCHYT ZÁSUVKOVÉHO A DVÍŘKOVÉHO PROFILU / DRAWER AND DOOR PROFILE HOLDER

270092	PLAST / PLASTIC
---------------	-----------------

- sada 2 příchyty pro upevnění profilu k bokům skříňě
- sofistikované řešení umožňující montáž profilu do již sestavené skříňky
- *set of 2 clips for fastening the profile to the sides of the cabinet*
- *enables to mount the profile to the cabinet which is already assembled*

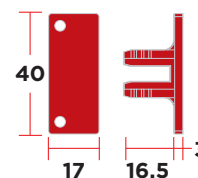
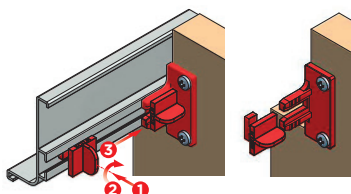

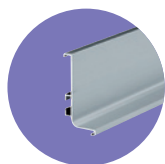

dvířkové a zásuvkové profily / door and drawer profiles

VERTIKÁLNÍ PROFILY GOLA / VERTICAL PROFILES GOLA

- profily pro bezúchytkové otevírání dveří skříní
- dostupilní 2 typy - boční a středový
- montáž samořeznými šrouby 4,2 mm
- profiles for handle-less door opening cabinets
- 2 types - the side and center
- installation of self-tapping screws 4.2 mm

BOČNÍ PROFIL 4,5 m / SIDE PROFILE 4.5 m

284161	IMITACE NEREZI / ST. STEEL IMITATION
235811	HLINÍK / ALUMINIUM
284162	BÍLÁ / WHITE

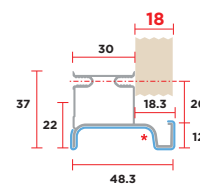

STŘEDOVÝ PROFIL 4,5 m / CENTRAL PROFILE 4.5 m

284163	IMITACE NEREZI / ST. STEEL IMITATION
235812	HLINÍK / ALUMINIUM
284164	BÍLÁ / WHITE

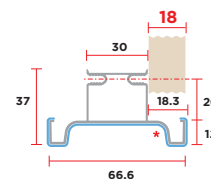

DVÍŘKOVÝ PROFIL 3,9 m PRO HORNÍ SKŘÍŇKY / DOOR PROFILE 3.9 m FOR UPPER CABINETS

228312	IMITACE NEREZI / ST. STEEL IMITATION
156848	HLINÍK / ALUMINIUM

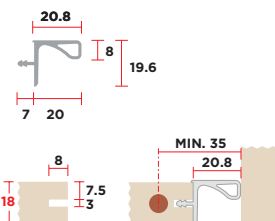
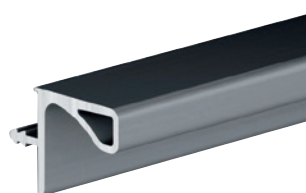

DVÍŘKOVÝ PROFIL 3,9 m PRO HORNÍ SKŘÍŇKY S TĚSNĚNÍM / DOOR PROFILE 3.9 m FOR UPPER CABINETS WITH SEALING

284165	HLINÍK PRO TL. 18 mm / ALUMINIUM FOR TH. 18 mm
302379	HLINÍK PRO TL. 16 mm / ALUMINIUM FOR TH. 16 mm

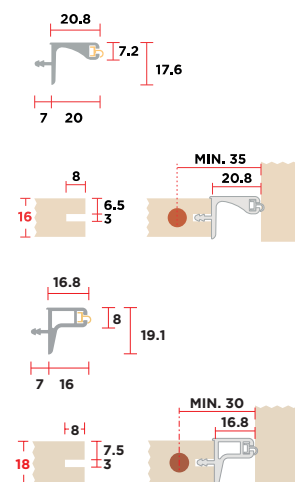
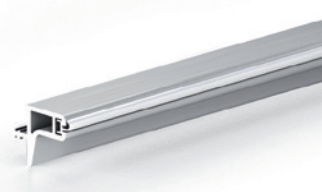

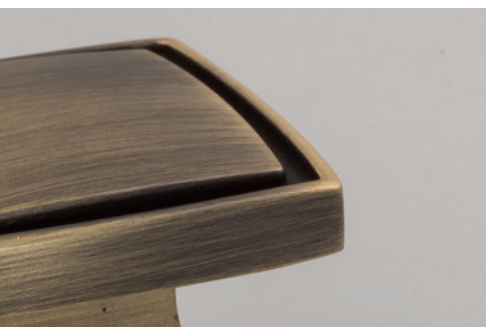
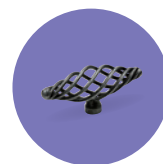

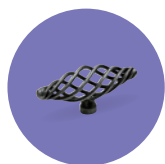

rustikální úchytky a knopky / rustic handles and knobs



CALEIDO



STAROMĚĎ / OLD COPPER	C (mm)	L (mm)
284263	128	149
284264	192	213
284265	320	341

CALEIDO

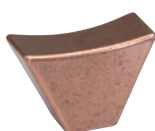

STAROMĚĎ /
PATINATED OLD

284266

SIRIUS



OXIDOVANÁ OCEL /
OXIDIZED STEEL EFFECT

	C (mm)	L (mm)	D (mm)	H (mm)
284267	96	142	21	28
284268	128	177	22	29
284269	160	210	25	30

SIRIUS

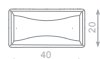

OXIDOVANÁ OCEL /
OXIDIZED STEEL EFFECT

284270

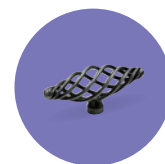

CURU

STAROBRONZ / OLD BRONZE	C (mm)	L (mm)
284222	128	158
284223	192	222

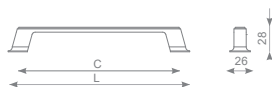

CURU

STAROBRONZ / OLD BRONZE
284221

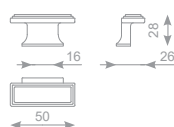

LOCARNO

BR. STAROBRONZ / BR. OLD BRONZE	BR. STAROSTŘÍBRO / BR. OLD SILVER
284322	284323



LOCARNO

BR. STAROBRONZ / BR. OLD BRONZE	BR. STAROSTŘÍBRO / BR. OLD SILVER
284319	284320

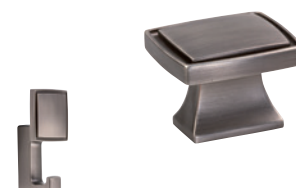

Věšák / hook LOCARNO
(str. / pg. 117)

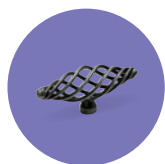

rustikální úchytky a knopky / rustic handles and knobs

MENISOLA

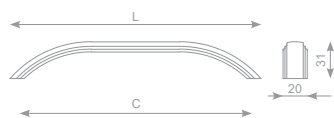

ANTIC BRONZ MATNÝ / ANTIC PBRONZE MATT	C (mm)	L (mm)
284218	192	209
284219	320	337
284220	480	497

DERBY

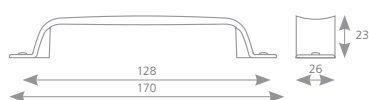

STAROČERNÁ / USED BLACK EFFECT	ČERNÁ OCEL LESK / BLACK SHINY STEEL	ČERNÁ OCEL MAT / MATT BLACK STEEL
202825	202826	202827

SULKY

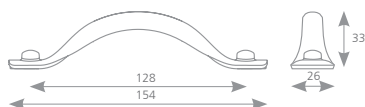

STAROČERNÁ / USED BLACK EFFECT	ČERNÁ OCEL LESK / BLACK SHINY STEEL	ČERNÁ OCEL MAT / MATT BLACK STEEL
202828	202829	202830

KENTUCKY DS



STAROČERNÁ / USED BLACK EFFECT	ČERNÁ OCEL LESK / BLACK SHINY STEEL	ČERNÁ OCEL MAT / MATT BLACK STEEL
202831	202832	202843

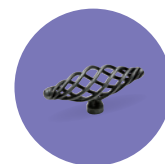

KENTUCKY

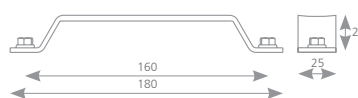

STAROČERNÁ /
USED BLACK EFFECT

202844

ČERNÁ OCEL LESK /
BLACK SHINY STEEL

202845

ČERNÁ OCEL MAT /
MATT BLACK STEEL

202846

TORONTO DS

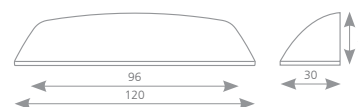

STAROČERNÁ /
USED BLACK EFFECT

202847

ČERNÁ OCEL LESK /
BLACK SHINY STEEL

202848

ČERNÁ OCEL MAT /
MATT BLACK STEEL

202849

TORONTO

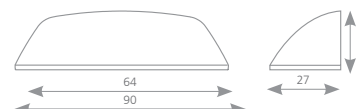

STAROČERNÁ /
USED BLACK EFFECT

202850

ČERNÁ OCEL LESK /
BLACK SHINY STEEL

202851

ČERNÁ OCEL MAT /
MATT BLACK STEEL

202852

CORSICA

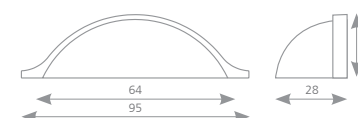

STAROČERNÁ /
USED BLACK EFFECT

202869

ČERNÁ OCEL LESK /
BLACK SHINY STEEL

202870

ČERNÁ OCEL MAT /
MATT BLACK STEEL

202871

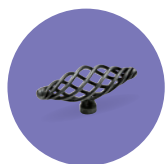

rustikální úchytky a knopky / rustic handles and knobs

SHELL

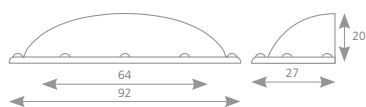

STAROČERNÁ /
USED BLACK EFFECT

ČERNÁ OCEL LESK /
BLACK SHINY STEEL

ČERNÁ OCEL MAT /
MATT BLACK STEEL

202872

202873

202874

LINEA

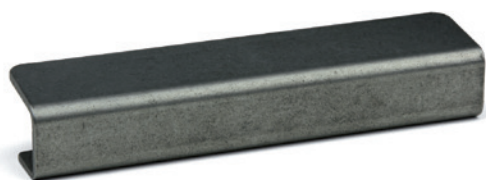

STAROČERNÁ /
USED BLACK EFFECT

ČERNÁ OCEL LESK /
BLACK SHINY STEEL

ČERNÁ OCEL MAT /
MATT BLACK STEEL

204085

204086

204087

STAMP

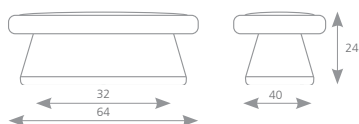

STAROČERNÁ /
USED BLACK EFFECT

ČERNÁ OCEL LESK /
BLACK SHINY STEEL

ČERNÁ OCEL MAT /
MATT BLACK STEEL

204107

204108

204109

CONA

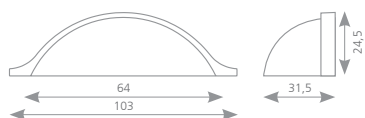

STAROMOSAZ /
OLD BRASS EFFECT

285004

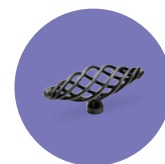

COTTAGE

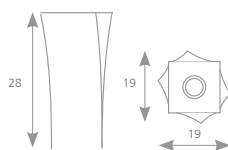

OXIDOVANÁ OCEL /
OXIDIZED STEEL EFFECT

42015

COTTAGE



OXIDOVANÁ OCEL /
OXIDIZED STEEL EFFECT

42013

C
(mm)

L
(mm)

42011

128

138

160

170

TUVOLA

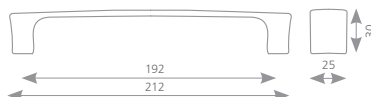

ČERNÁ OCEL MAT /
MATT BLACK STEEL

267109

TUVOLA

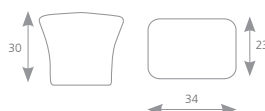

ČERNÁ OCEL MAT /
MATT BLACK STEEL

267122

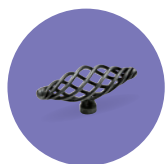

rustikální úchytky a knoflíky / rustic handles and knobs



SERENA



STAROMĚŘ / OLD COPPER	C (mm)	L (mm)
157282	96	115
157283	128	147
157284	160	180

SERENA

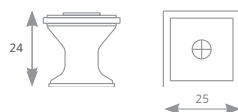

STAROMĚŘ /
OLD COPPER

157285

SERENA

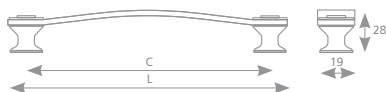

ANTIK ENGLISH / ANTIC ENGLISH	C (mm)	L (mm)
203443	96	115
203444	128	147

SERENA



ANTIK ENGLISH /
ANTIC ENGLISH

203446

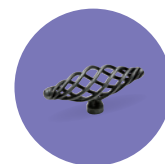

RUSTIK

STAROMOSAZ / OLD BRASS	STAROSTŘÍBRO / OLD SILVER	C (mm)	L (mm)
296149	296156	128	149
296150	296157	160	181
296151	296158	192	213
296152	296159	224	245
296153	296160	256	277
296154	296161	320	341
296155	296162	448	469

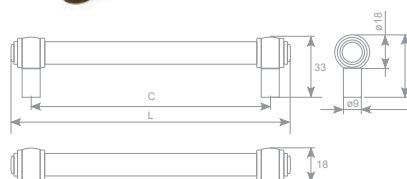
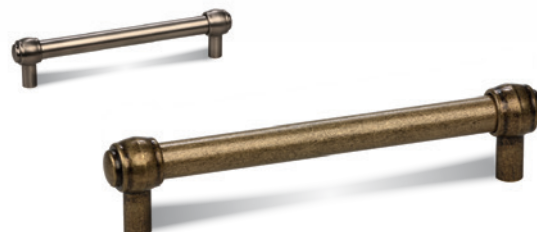

RUSTIK

STAROMOSAZ / OLD BRASS	STAROSTŘÍBRO / OLD SILVER
296164	296165

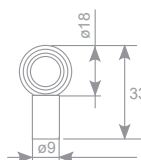

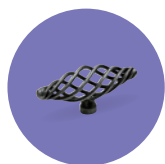

rustikální úchytky a knopky / rustic handles and knobs

TOMO

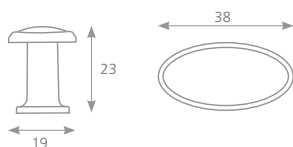

STAROCÍN /
OLD TIN

STAROMĚĎ /
OLD COPPER EFFECT

226917

226918

TOMO

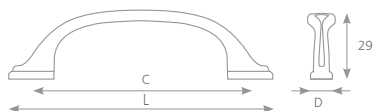

STAROCÍN /
OLD TIN

STAROMĚĎ /
OLD COPPER EFFECT

C
(mm)

L
(mm)

D
(mm)

226919

226920

96

132

14

226921

226922

160

204

16

DORA



STAROCÍN /
OLD TIN

STAROMĚĎ /
OLD COPPER EFFECT

226968

226970

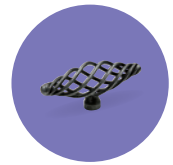

ULIKO



STAROMOSAZ / OLD BRASS EFFECT	C (mm)	L (mm)
157265	96	141
157266	128	173

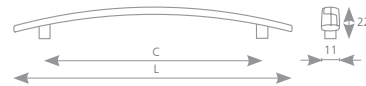

STOCKHOLM

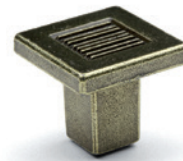

TMAVÝ BRONZ / DARK BRONZE	OXIDOVANÁ OCEL / OXIDIZED STEEL EFFECT	SVĚTLÝ BRONZ / LIGHT BRONZE EFFECT
157660	157661	157662

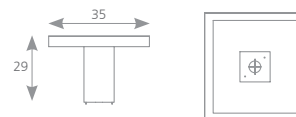

STOCKHOLM

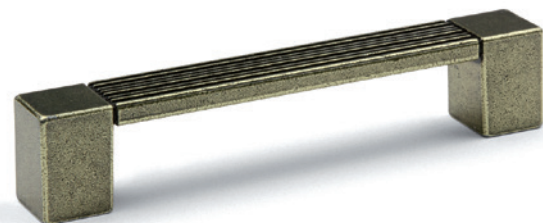

TMAVÝ BRONZ / DARK BRONZE	OXIDOVANÁ OCEL / OXIDIZED STEEL EFFECT	SVĚTLÝ BRONZ / LIGHT BRONZE EFFECT
157663	157664	157665



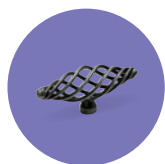

rustikální úchytky a knopky / rustic handles and knobs

tulip

VIRELLA

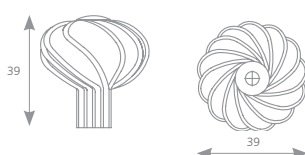

TMAVÁ OCEL /
DARK STEEL

157279

VIRELLA M

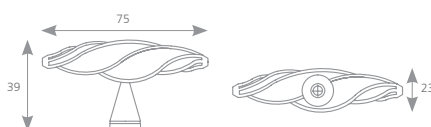

TMAVÁ OCEL /
DARK STEEL

157280

VIRELLA L

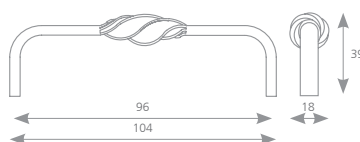

TMAVÁ OCEL /
DARK STEEL

157281

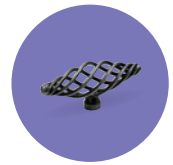

VICTORIA



OXIDOVANÁ OCEL /
OXIDIZED STEEL EFFECT

42104

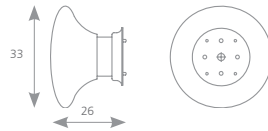

VICTORIA



OXIDOVANÁ OCEL /
OXIDIZED STEEL EFFECT

42103

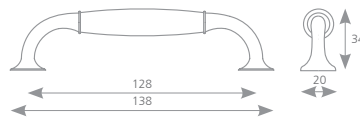

VICTORIA



PATINOVANÝ BRONZ /
PATINATED BRONZE

157684

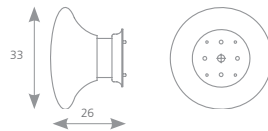

VICTORIA



PATINOVANÝ BRONZ /
PATINATED BRONZE

157685

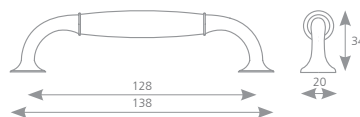



porcelánové úchytky / porcelain handles



MACIS

Porcelán bílý / White porcelain



OLD AMERICA /
OLD AMERICA

284279

MACIS

Porcelán bílý / White porcelain

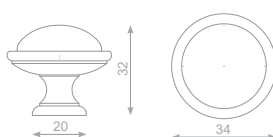

OLD AMERICA /
OLD AMERICA

284280

LENIS

Porcelán bílý / White porcelain



MAT - KOV / MATT - METAL	C (mm)	L (mm)	D (mm)	H (mm)
284275	96	111	22	41
284274	128	145	24	48

LENIS

Porcelán bílý / White porcelain



	MAT - KOV / MATT - METAL	L (mm)	D (mm)	H (mm)
L	284276	39	39	34
M	284278	34	34	29



BOSA

Porcelán / Porcelain



CHROM - KRÉMOVÁ /
CHROME CREAM

288053

CHROM - LINES /
CHROM - LINES

288054

STAROMOSAZ-FLOWER /
OLD BRASS-FLOWER

288055

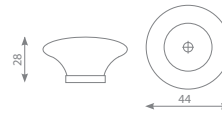

VENICE R

Porcelán bílý / White porcelain



STAROSTŘÍBRO /
OLD SILVER

288058

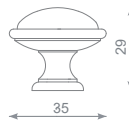

VENICE O

Porcelán bílý / White porcelain



STAROSTŘÍBRO /
OLD SILVER

288057



VENICE

Porcelán bílý / White porcelain



STAROSTŘÍBRO /
OLD SILVER

288056

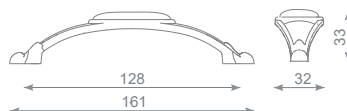



porcelánové úchytka / porcelain handles



MARGARITA

Porcelán bílý / White porcelain

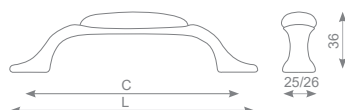

STAROSTŘÍBRO / OLD SILVER	C (mm)	L (mm)
288805	96	127
288800	128	159

MARGARITA

Porcelán bílý / White porcelain



	STAROSTŘÍBRO / OLD SILVER	L (mm)	D (mm)	H (mm)
○	288810	35	35	27
◌	288815	58	34	25

MARGARITA

Porcelán bílý / White porcelain

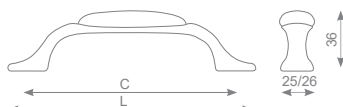

STAROSTŘÍBRO / OLD SILVER	C (mm)	L (mm)
288806	96	127
288801	128	159

MARGARITA

Porcelán bílý / White porcelain



	STAROSTŘÍBRO / OLD SILVER	L (mm)	D (mm)	H (mm)
○	288811	35	35	27
◌	288816	58	34	25



MARGARITA

Porcelán béžový / Beige porcelain



STAROMOSAZ / OLD BRASS	C (mm)	L (mm)
288807	96	127
288802	128	159

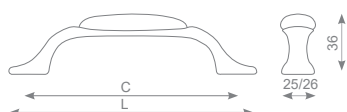

MARGARITA

Porcelán béžový / Beige porcelain



STAROMOSAZ / OLD BRASS	L (mm)	D (mm)	H (mm)	
288812	35	35	27	○
288817	58	34	25	◌



MARGARITA

Porcelán béžový / Beige porcelain



STAROMOSAZ / OLD BRASS	C (mm)	L (mm)
288808	96	127
288803	128	159

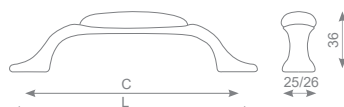

MARGARITA

Porcelán béžový / Beige porcelain



STAROMOSAZ / OLD BRASS	L (mm)	D (mm)	H (mm)	
288813	35	35	27	○
288818	58	34	25	◌





porcelánové úchytky / porcelain handles



MARGARITA

Porcelán béžový / Beige porcelain

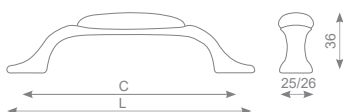

COUNTRY BRONZE / COUNTRY BRONZE	C (mm)	L (mm)	D (mm)
288809	96	127	26
288804	128	159	25

MARGARITA

Porcelán béžový / Beige porcelain

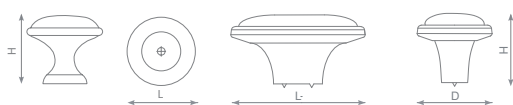

COUNTRY BRONZE / COUNTRY BRONZE	L (mm)	D (mm)	H (mm)
○ 288814	35	35	27
○ 288819	58	34	25

SARA

Porcelán bílý / White porcelain

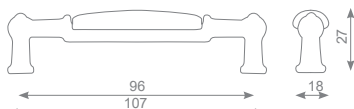

STAROSTŘÍBRO / OLD SILVER	STAROMOSAZ / OLD BRASS
288823	288824

STELA

Porcelán bílý / White porcelain



STAROSTŘÍBRO / OLD SILVER	STAROMOSAZ / OLD BRASS
288820	288821



COUNTRY

Porcelán popraskaný / Cracked porcelain

TMAVÝ BRONZ /
DARK BRONZE

42102

OXIDOVANÁ OCEL /
STEEL OXIDIZED

157676

JASNÝ BRONZ /
BRIGHT BRONZE

157679

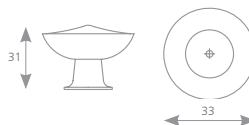

COUNTRY

Porcelán popraskaný / Cracked porcelain

TMAVÝ BRONZ /
DARK BRONZE

42101

OXIDOVANÁ OCEL /
STEEL OXIDIZED

157677



COUNTRY

Porcelán popraskaný / Cracked porcelain

TMAVÝ BRONZ /
DARK BRONZE

42100

OXIDOVANÁ OCEL /
STEEL OXIDIZED

157678

JASNÝ BRONZ /
BRIGHT BRONZE

157681

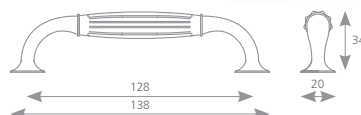

CARAT

Porcelán béžový / Beige porcelain

TMAVÝ BRONZ /
DARK BRONZE

42105

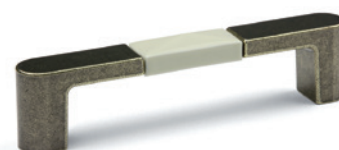
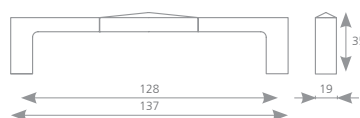



dřevěné úchytky / wooden handles



BALA

Barvené dřevo / colored wood

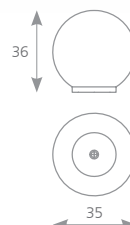

TMAVĚ MODRÁ / DARK BLUE	MODRÁ / BLUE	ČERVENÁ / BLACK	RŮŽOVÁ / PINK	ORANŽOVÁ / ORANGE	FIALOVÁ / LILAC	ZELENÁ / GREEN	OLIVOVÁ / OLIVE
212674	09497	09489	09490	158702	09491	09492	09493

SOLA

Barvené dřevo / colored wood

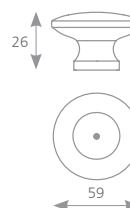

MODRÁ / BLUE	ČERVENÁ / BLACK	RŮŽOVÁ / PINK	ORANŽOVÁ / ORANGE	ZELENÁ / GREEN	OLIVOVÁ / OLIVE	ŽLUTÁ / YELLOW
158717	158718	158719	158720	158721	158722	158723

MUNA

Barvené dřevo / colored wood

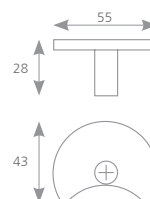

ŽLUTÁ / YELLOW	MODRÁ / BLUE	ORANŽOVÁ / ORANGE	FIALOVÁ / LILAC	ČERVENÁ / BLACK	OLIVOVÁ / OLIVE
158710	158711	158713	158714	158715	158716



JACEK

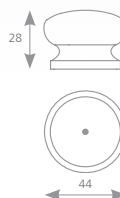

DUB LAK /
OAK LACQUERED

BOROVICE LAK /
PINE LACQUERED

BUK LAK /
BEECH LACQUERED

OLŠE LAK /
ALDER LACQUERED

BOROVICE SUROVÁ /
PINE (UNPAINTED)

BUK SUROVÝ /
BEECH (UNPAINTED)

09401

09402

09403

09404

158698

158699

ADAM

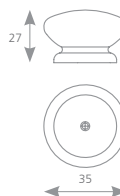

DUB LAK /
OAK LACQUERED

BOROVICE LAK /
PINE LACQUERED

BUK LAK /
BEECH LACQUERED

OLŠE LAK /
ALDER LACQUERED

BOROVICE SUROVÁ /
PINE (UNPAINTED)

BUK SUROVÝ /
BEECH (UNPAINTED)

09409

09410

09411

09412

158703

158704

OLZA

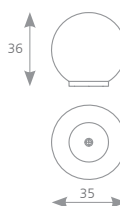

BOROVICE LAK /
PINE LACQUERED

BUK LAK /
BEECH LACQUERED

BOROVICE SUROVÁ /
PINE (UNPAINTED)

BUK SUROVÝ /
BEECH (UNPAINTED)

09406

09407

158700

158701

JURA

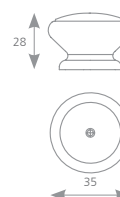

DUB LAK /
OAK LACQUERED

BOROVICE LAK /
PINE LACQUERED

BUK LAK /
BEECH LACQUERED

OLŠE LAK /
ALDER LACQUERED

09413

09414

09415

09416



dřevěné úchytky / wooden handles

BUSTYNA

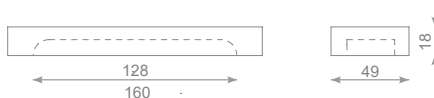

BUK SUROVÝ /
BEECH (UNPAINTED)

284817

MATRA

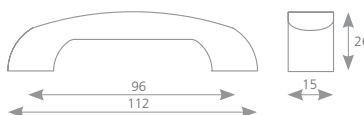

DUB LAK /
OAK LACQUERED

09430

BOROVICE LAK /
PINE LACQUERED

09431

BUK LAK /
BEECH LACQUERED

09432

OLŠE LAK /
ALDER LACQUERED

09433

BERGA



DUB LAK /
OAK LACQUERED

09459

BOROVICE LAK /
PINE LACQUERED

09460

BUK LAK /
BEECH LACQUERED

09461

OLŠE LAK /
ALDER LACQUERED

09462



PIERA



BUK - SATIN CHROM / BEECH - SATIN CHROME	C (mm)	L (mm)
37820	96	125
37821	128	157



FILA



BUK - SATIN CHROM / BEECH - SATIN CHROME	C (mm)	L (mm)
37823	96	130
37824	128	162

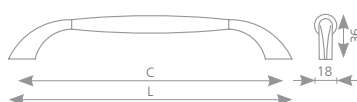

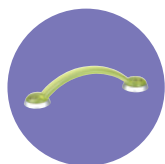

plastové úchytky / plastic handles



MODO Q

Měkčený plast / Softened plastic

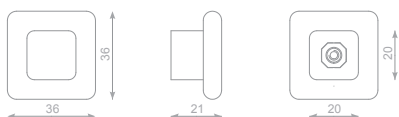

ZELENÁ /
GREEN

284535

BÍLÁ /
WHITE

284533

ORANŽOVÁ /
ORANGE

284534

MODO R

Měkčený plast / Softened plastic

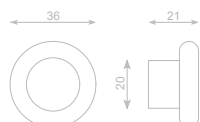

BÍLÁ /
WHITE

284536

ORANŽOVÁ /
ORANGE

284537

ZELENÁ /
GREEN

284538

P435

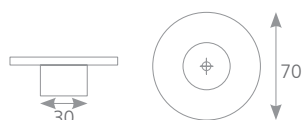
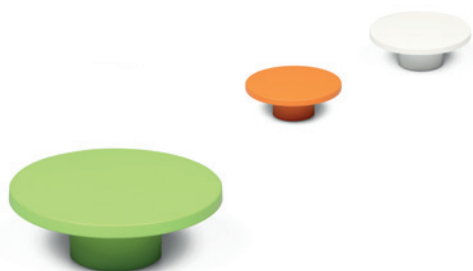

ZELENÁ /
GREEN

265488

BÍLÁ /
WHITE

265486

ORANŽOVÁ /
ORANGE

265487

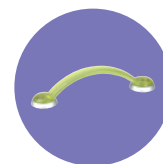

P431



ORANŽOVÁ /
ORANGE

265484

BÍLÁ /
WHITE

265483

ZELENÁ /
GREEN

265485

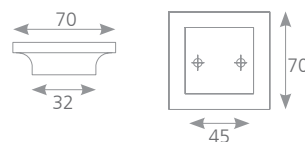

M306

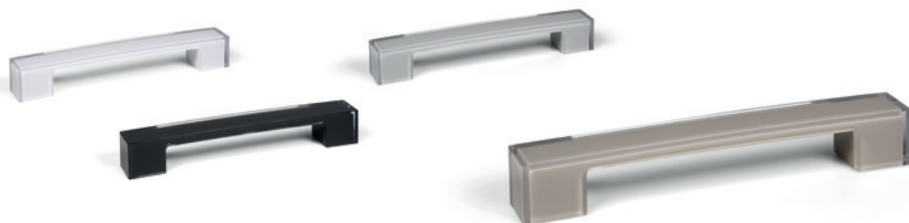

BÍLÁ /
WHITE

265479

ČERNÁ /
BLACK

265480

ŠEDÁ /
GRAY

265481

BÉŽOVÁ /
BEIGE

265482

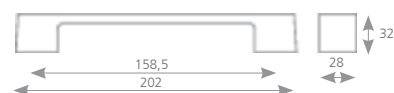

P603

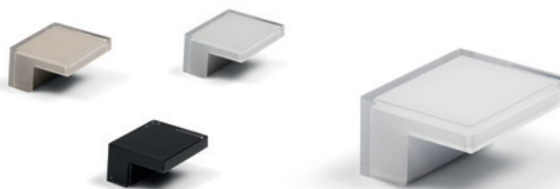

BÉŽOVÁ /
BEIGE

265475

BÍLÁ /
WHITE

265471

ČERNÁ /
BLACK

265473

ŠEDÁ /
GRAY

265474

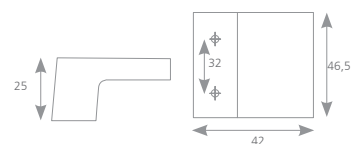

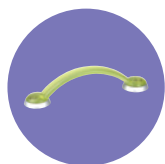

plastové úchytky / plastic handles



NAKANA



RŮŽOVÁ / PINK	ZELENÁ / GREEN	BÍLÁ / WHITE	MODRÁ / BLUE	C (mm)	L (mm)	D (mm)	H (mm)
303197	303201	303209	303205	64	86	10	26
303198	303202	303210	303206	96	122	9	26
303199	303203	303211	303207	128	150	9	29
303200	303204	303212	303208	160	200	9	30

FUNGA

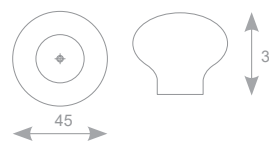

RŮŽOVÁ / PINK	ZELENÁ / GREEN	BÍLÁ / WHITE	MODRÁ / BLUE
303233	303234	303236	303235

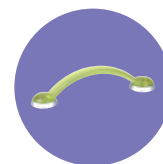

NELA

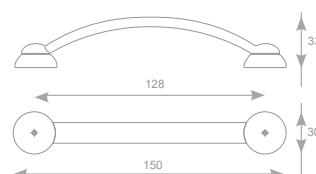

ORANŽOVÁ / ORANGE	ZELENÁ / GREEN	BÍLÁ / WHITE	MODRÁ / BLUE
303231	303232	303230	303229

EVA

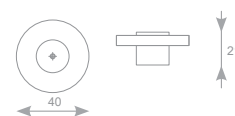
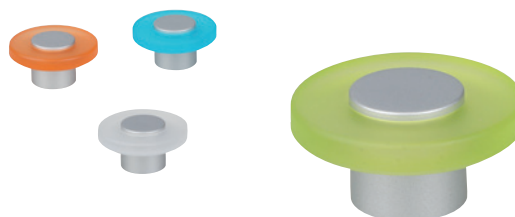

ORANŽOVÁ / ORANGE	BÍLÁ / WHITE	MODRÁ / BLUE	ZELENÁ / GREEN
303227	303226	303225	303228

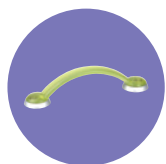

plastové úchytky / plastic handles



EMA

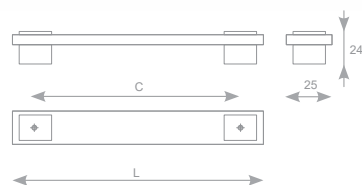
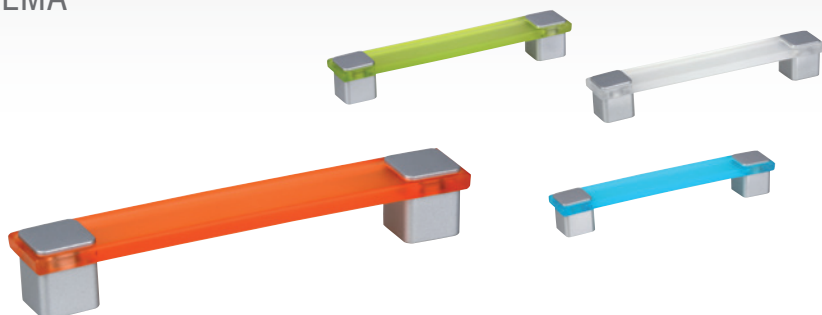

ORANŽOVÁ / ORANGE	ZELENÁ / GREEN	BÍLÁ / WHITE	MODRÁ / BLUE	C (mm)	L (mm)
303217	303219	303215	303213	128	150
303218	303220	303216	303214	160	183

EMA KNOP

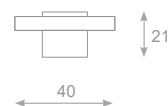
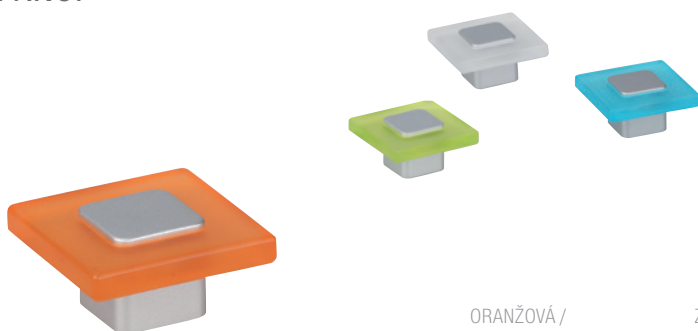

ORANŽOVÁ / ORANGE	ZELENÁ / GREEN	BÍLÁ / WHITE	MODRÁ / BLUE
303223	303224	303222	303221

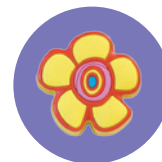

FIORA

Měkčený plast / Softened plastic



FIORA

Měkčený plast / Softened plastic



FIORA

Měkčený plast / Softened plastic



PIAZZA

Měkčený plast / Softened plastic

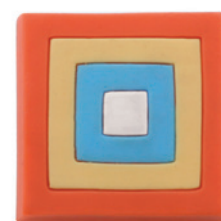

	L (mm)	D (mm)	H (mm)
222116	44	44	23

	L (mm)	D (mm)	H (mm)
222117	44	44	23

	L (mm)	D (mm)	H (mm)
152866	44	44	23

	L (mm)	D (mm)	H (mm)
171121	40	40	24

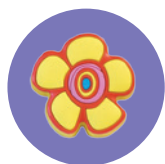

STELLA

Měkčený plast / Softened plastic



	L (mm)	D (mm)	H (mm)
231462	50	50	24

PALLA

Měkčený plast / Softened plastic



	L (mm)	D (mm)	H (mm)
198702	40	40	28

FISK

Měkčený plast / Softened plastic

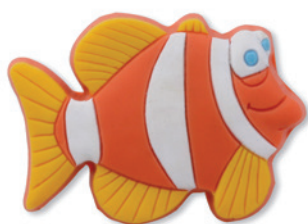

	L (mm)	D (mm)	H (mm)
101074	53	39	24

CHAT

Měkčený plast / Softened plastic



	L (mm)	D (mm)	H (mm)
198703	51	35	24

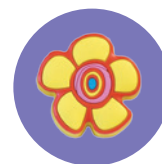

RANA

Měkčený plast / Softened plastic



	L (mm)	D (mm)	H (mm)
198704	45	50	23

PERCHA V

Tvrzený plast / Laminated plastic



	L (mm)	D (mm)	H (mm)
231453	400	50	48

PERCHA I

Tvrzený plast / Laminated plastic



	L (mm)	D (mm)	H (mm)
231454	27	22	100

PERCHA IV

Tvrzený plast / Laminated plastic



	L (mm)	D (mm)	H (mm)
231455	300	30	36

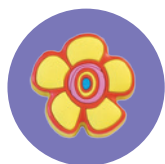

PERCHA II

Tvrzený plast / Laminated plastic



	L (mm)	D (mm)	H (mm)
231456	164	25	25

PERCHA

Tvrzený plast / Laminated plastic



	L (mm)	D (mm)	H (mm)
231469	36	36	28

TREN IV

Tvrzený plast / Laminated plastic



	L (mm)	D (mm)	H (mm)
231457	300	30	36

TREN I

Tvrzený plast / Laminated plastic



	L (mm)	D (mm)	H (mm)
231458	27	22	100

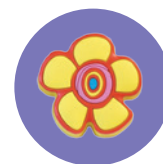

TREN

Tvrzený plast / Laminated plastic



	L (mm)	D (mm)	H (mm)
--	-----------	-----------	-----------

231459

	36	36	38
--	----	----	----

TREN II

Tvrzený plast / Laminated plastic



	L (mm)	D (mm)	H (mm)	C (mm)
--	-----------	-----------	-----------	-----------

231460

	164	25	25	128
--	-----	----	----	-----

TREN V

Tvrzený plast / Laminated plastic



	L (mm)	D (mm)	H (mm)
--	-----------	-----------	-----------

231470

	400	50	48
--	-----	----	----



věšáky / hooks

EXTENDO S

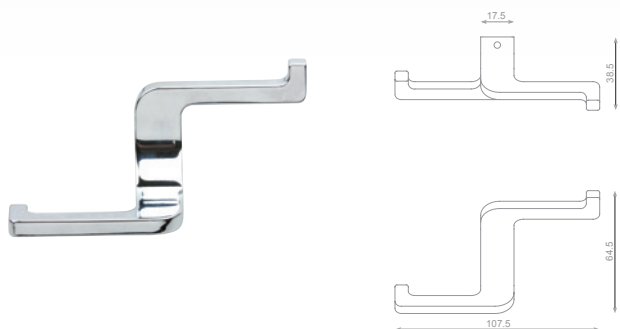

CHROM /
CHROME

SATIN CHROM /
MATT - CHROME

SATIN NIKL /
NICKEL MATT

283967

283968

283969

EXTENDO U

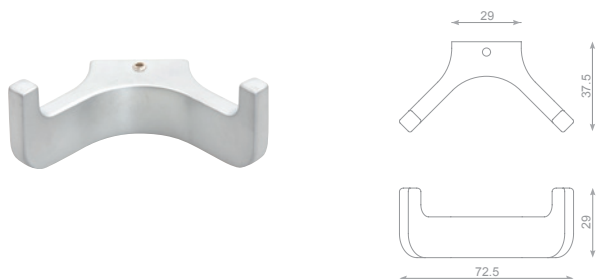

CHROM /
CHROME

SATIN CHROM /
CHROME MATT

SATIN NIKL /
NICKEL MATT

283964

283965

283966

BELLUNA

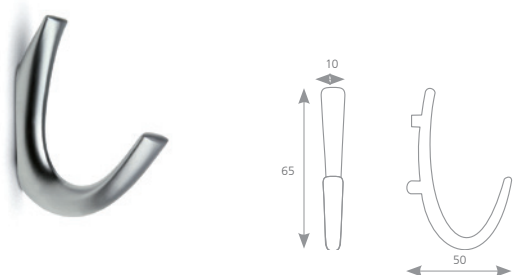

CHROM /
CHROME

SATIN CHROM /
CHROME MATT

BROUŠENÝ NIKL /
BRUSHED NICKEL

157323

157321

157322

BELLUNA XL

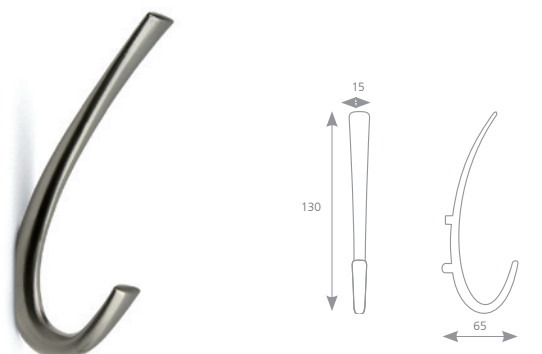

CHROM /
CHROME

SATIN CHROM /
CHROME MATT

BROUŠENÝ NIKL /
BRUSHED NICKEL

157326

157324

157325



DONA



CHROM /
CHROME

202855

SATIN CHROM /
CHROME MATT

202856

NIKL MATNÝ /
MATT NICKEL

202857

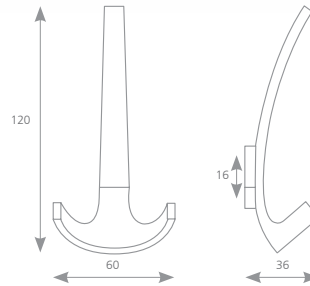

HONZA



IMITACE NEREZI /
ST. STEEL IMITATION

10460

SATIN CHROM /
MATT CHROME

10462

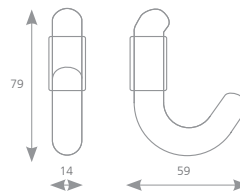

HONZA XL



IMITACE NEREZI /
ST. STEEL IMITATION

10463

SATIN CHROM /
MATT CHROME

10465

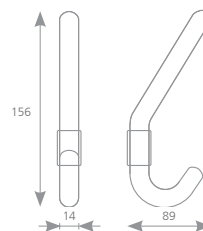

IWO



IMITACE NEREZI /
ST. STEEL IMITATION

289683

SATIN CHROM /
MATT CHROME

289684

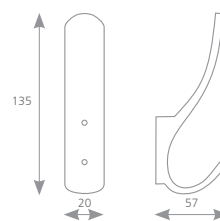



věšáky / hooks



PERA

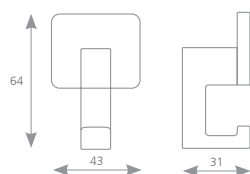

STŘÍBRNÁ /
SILVER

BROUŠENÝ NIKL /
BRUSHED NICKEL

77812

77813

ROSA

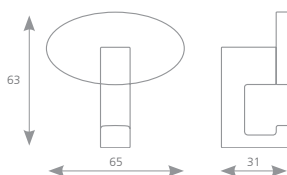

STŘÍBRNÁ /
SILVER

BROUŠENÝ NIKL /
BRUSHED NICKEL

77811

77810

VICTORY

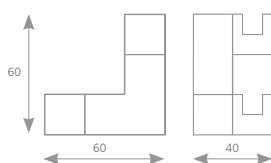

STŘÍBRNÁ /
SILVER

SATIN NIKL /
NICKEL MATT

77827

77828

FRANCA

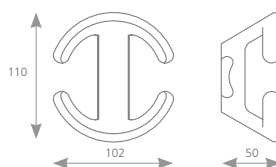

STŘÍBRNÁ /
SILVER

SATIN CHROM /
CHROME MATT

77815

77814



DORIS



CHROM /
CHROME

204686

SATIN CHROM /
CHROME MATT

204687

SATIN NIKL /
NICKEL MATT

204688

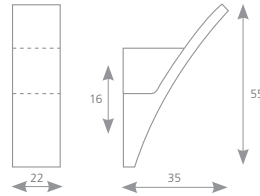

ROCATA



ČERNÁ /
BLACK

284108

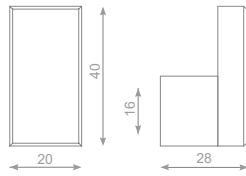

úchytka / handle ROCATA
(str. / pg. 10)



LAURA



ČERNÁ /
BLACK

320989

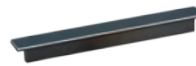
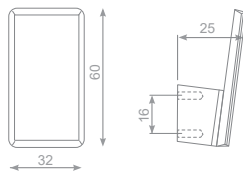

úchytka / handle LAURA
(str. / pg. 11)



DYAN



SATIN NIKL /
NICKEL MATT

231588

SATIN CHROM /
CHROME MATT

231589

CHROM /
CHROME

231590

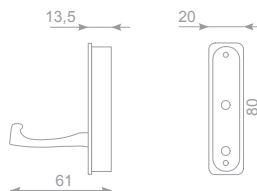



věšáky / hooks



TARASA

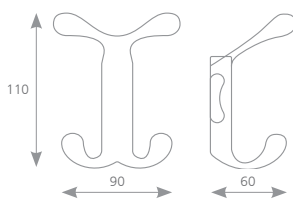

STŘÍBRNÁ /
SILVER

SATIN NIKL /
NICKEL MATT

77806

77807



ROBERTO

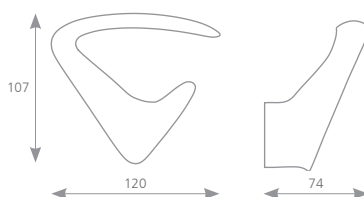

STŘÍBRNÁ /
SILVER

77818



MELA

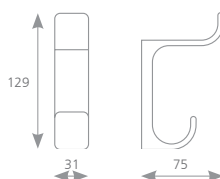

STŘÍBRNÁ /
SILVER

77800



ROKOS

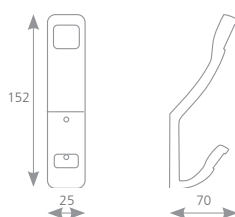

SATIN NIKL /
NICKEL MATT

SATIN CHROM /
CHROME MATT

289681

289682





DAX



SATIN CHROM /
CHROME MATT

157327

SATIN NIKL /
NICKEL MATT

157328

CHROM /
CHROME

157329

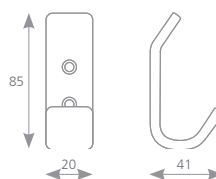

TELUS



SATIN NIKL /
NICKEL MATT

289689

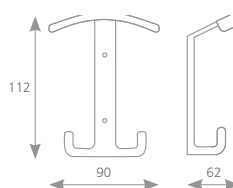

ILAN



SATIN NIKL /
NICKEL MATT

289687

SATIN CHROM /
CHROME MATT

289688

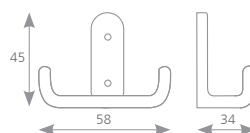

LUGO



SATIN NIKL /
NICKEL MATT

35581

SATIN CHROM /
CHROME MATT

35582

CHROM /
CHROME

35583

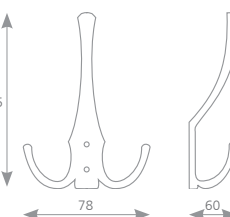

MOSAZ /
BRASS

35584

ČERNÁ /
BLACK

35585





věšáky / hooks

DAVOS

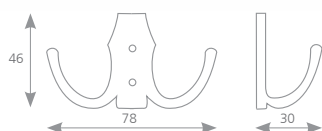

SATIN NIKL /
NICKEL MATT

SATIN CHROM /
CHROME MATT

CHROM /
CHROME

MOSAZ /
BRASS

ČERNÁ /
BLACK

35591

35592

35593

35594

35595

PETROS



STAROMĚĎ /
OLD COPPER

STAROCÍN /
OLD TIN

SATIN CHROM /
CHROME MATT

CHROM /
CHROME

226989

226990

226991

226992

DAREC XL

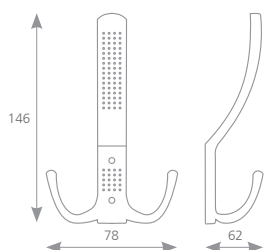

CHROM /
CHROME

SATIN CHROM /
CHROME MATT

SATIN NIKL /
NICKEL MATT

289677

289678

308967

DAREC

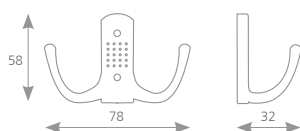

CHROM /
CHROME

SATIN CHROM /
CHROME MATT

SATIN NIKL /
NICKEL MATT

289679

289680

308965

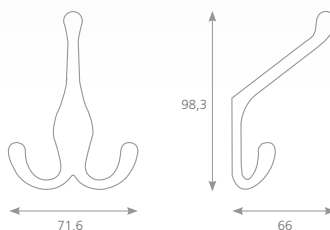

CARLOS



SATIN CHROM /
CHROME MATT

226993

CHROM /
CHROME

226994

STAROCÍN /
OLD TIN

226995

STAROMĚŘ /
OLD COPPER

226996

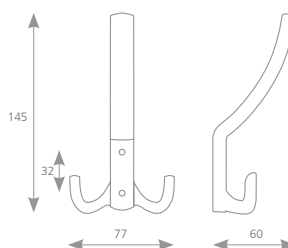

MARCEL XL



CHROM /
CHROME

290150

SATIN CHROM /
CHROME MATT

290151

SATIN NIKL /
NICKEL MATT

290152

MARCEL S

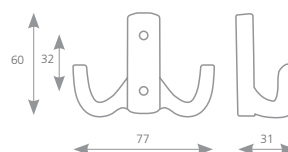

CHROM /
CHROME

290153

SATIN CHROM /
CHROME MATT

290154

SATIN NIKL /
NICKEL MATT

290155

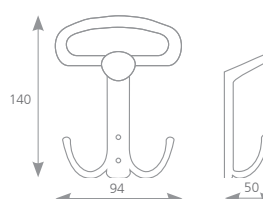

TAMOS



SATIN NIKL /
NICKEL MATT

35601

SATIN CHROM /
CHROME MATT

35602



věšáky / hooks

TRIAS

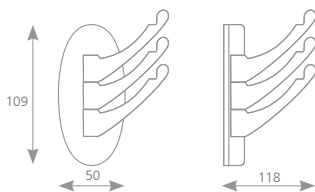

CHROM /
CHROME

SATIN NIKL /
NICKEL MATT

289673

289674



RAPALLO

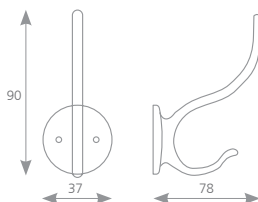

SATIN NIKL /
NICKEL MATT

SATIN CHROM /
CHROME MATT

CHROM /
CHROME

MOSAZ /
BRASS

ČERNÁ /
BLACK

35621

35622

35623

35624

35625



UNICO

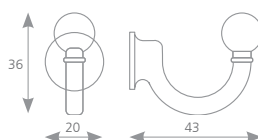

SATIN NIKL /
NICKEL MATT

SATIN CHROM /
CHROME MATT

CHROM /
CHROME

MOSAZ /
BRASS

35571

35572

35573

35574



FERA

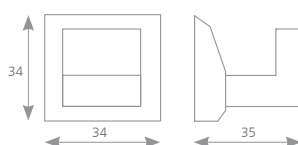

SATIN CHROM /
CHROME MATT

35991





KARA L



BROUŠENÝ NIKL /
BRUSHED NICKEL

284990

CHROM /
CHROME

284993

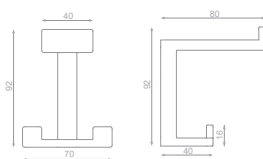

KARA M



BROUŠENÝ NIKL /
BRUSHED NICKEL

284989

CHROM /
CHROME

284992

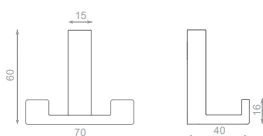

KARA S



BROUŠENÝ NIKL /
BRUSHED NICKEL

284988

CHROM /
CHROME

284991

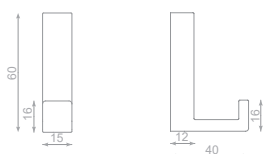

CARPO



SATIN CHROM /
CHROME MATT

157313

BROUŠENÝ NIKL /
BRUSHED NICKEL

157315

SATIN NIKL /
NICKEL MATT

157316

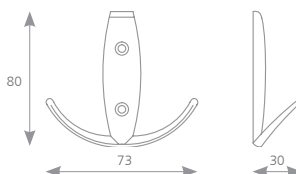



věšáky / hooks

LIVORNO

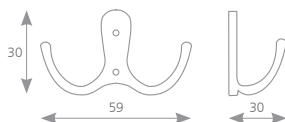

SATIN NIKL / NICKEL MATT	SATIN CHROM / CHROME MATT	CHROM / CHROME	MOSAZ / BRASS	ČERNÁ / BLACK
35611	35612	35613	35614	35615

LERICO

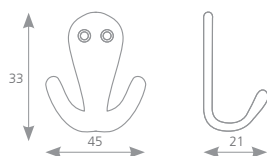

SATIN CHROM / CHROME MATT	SATIN NIKL / NICKEL MATT	CHROM / CHROME
157330	157331	157332

MUSO

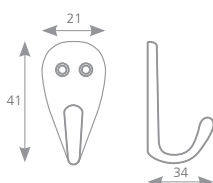

SATIN CHROM / CHROME MATT	SATIN NIKL / NICKEL MATT	CHROM / CHROME
157333	157334	157335



STAROMOSAZ /
OLD BRASS EFFECT

157319

TMAVÁ PATINA /
PATINATED STEEL

157320

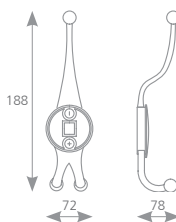

MURERO XL



MURERO



STAROMOSAZ /
OLD BRASS EFFECT

157317

TMAVÁ PATINA /
PATINATED STEEL

157318

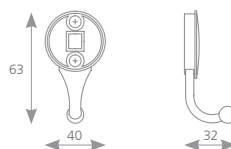

ORIO XL



STAROMOSAZ /
OLD BRASS EFFECT

36768

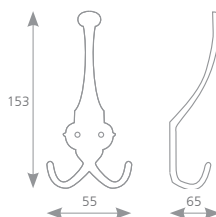

ORIO



STAROMOSAZ /
OLD BRASS EFFECT

36769

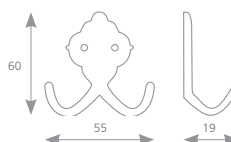



věšáky / hooks

LOCARNO



úchytka / handle LOCARNO
(str. / pg. 74)



knopka / knob LOCARNO
(str. / pg. 74)

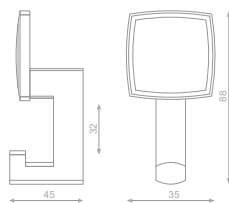

BR. STAROBRONZ /
BR. OLD BRONZE

BR. STAROSTŘÍBRO /
BR. OLD SILVER

284314

284315



RUBICO XL

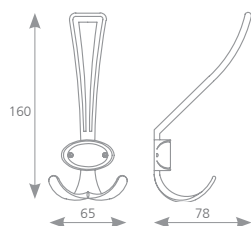

TMAVÁ PATINA /
PATINATED STEEL

STAROMOSAZ /
OLD BRASS EFFECT

STAROMĚŘ /
OLD COPPER EFFECT

BR. STAROMĚŘ /
BR. OLD COPPER EFFECT

157311

157312

205957

226976



RUBICO

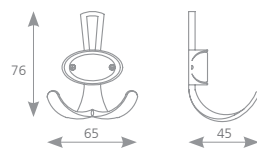

TMAVÁ PATINA /
PATINATED STEEL

STAROMOSAZ /
OLD BRASS EFFECT

STAROMĚŘ /
OLD COPPER EFFECT

BR. STAROMĚŘ /
BR. OLD COPPER EFFECT

STAROCÍN /
OLD TIN EFFECT

157309

157310

205956

226969

226967





ARAMIS L



STAROMOSAZ /
OLD BRASS EFFECT

284272

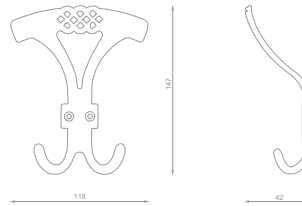

ARAMIS M



STAROMOSAZ /
OLD BRASS EFFECT

284273

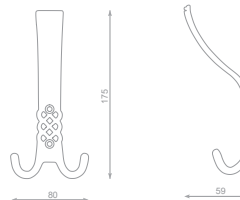

ARAMIS S



STAROMOSAZ /
OLD BRASS EFFECT

284271

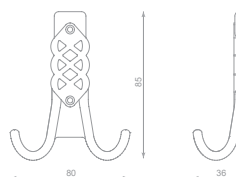



věšáky / hooks

RUZA



SATIN NIKL / NICKEL MATT	SATIN CHROM / CHROME MATT	BROUŠENÝ NIKL / BRUSHED NICKEL	CHROM / CHROME	ČERNÁ / BLACK	L (mm)	D (mm)
157289	157290	157291	157292	157293	16	27
157294	157295	157296	157297	157299	21	35

TOWELO

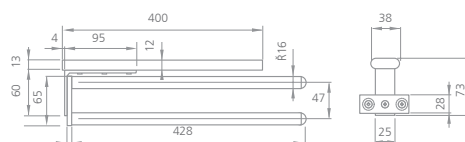

HLINÍK /
ALUMINIUM

36725



EXTENDO

