

## Technikai információk – Beszerelési méretek

H	Minimális beépítési mélység	Beépítési méret - előlap	Beépítési méret - hátlap
94	 <p>Technical drawing showing the minimum installation depth dimensions for the door handle assembly. The dimensions are:</p> <ul style="list-style-type: none"><li>min 114 (total depth)</li><li>109.5 (depth to the start of the handle)</li><li>min 26.5 (depth to the start of the mounting plate)</li><li>min 38.5 (depth to the end of the mounting plate)</li></ul>	 <p>Technical drawing showing the front panel installation dimensions for the door handle assembly. The dimensions are:</p> <ul style="list-style-type: none"><li>15.5 (width of the front panel)</li><li>32 (height of the front panel)</li><li>min 60.5 (depth to the start of the mounting plate)</li></ul>	 <p>Technical drawing showing the back panel installation dimensions for the door handle assembly. The dimensions are:</p> <ul style="list-style-type: none"><li>7.5 (width of the back panel)</li><li>32 (height of the back panel)</li><li>8 (height of the mounting plate)</li></ul>

### Fióksínhez tartozó furatok elhelyezkedése

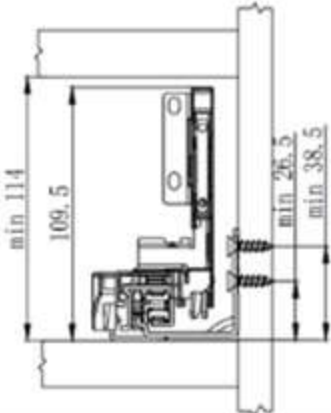
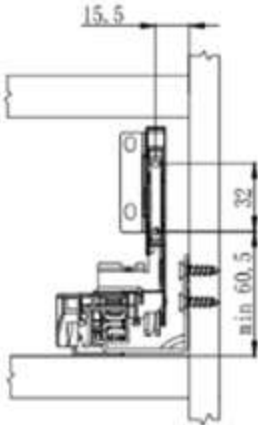
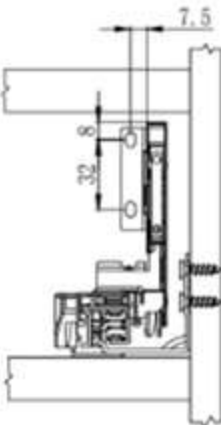
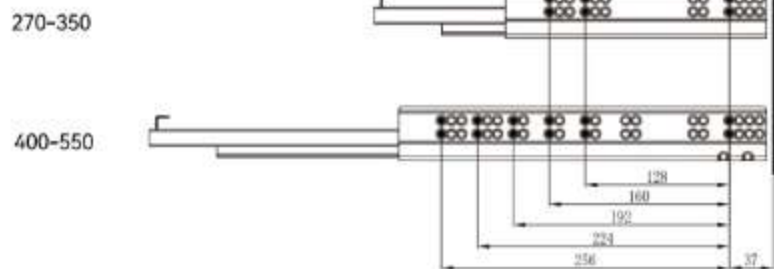

### Fióksínhez tartozó furatok elhelyezkedése - Belső fiókhöz

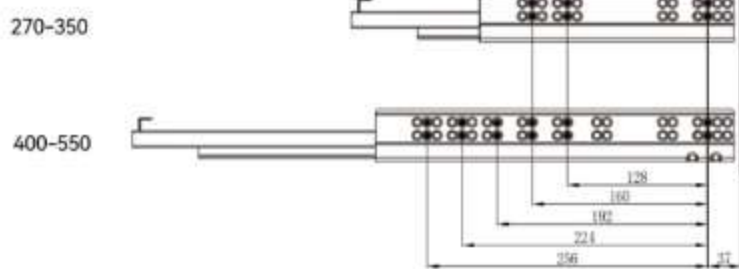

### Minimum fiókmélység

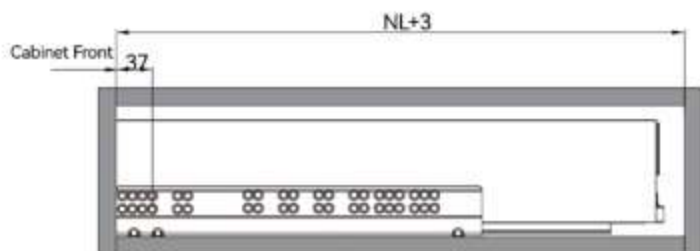

### Minimum fiókmélység belső fiókhöz

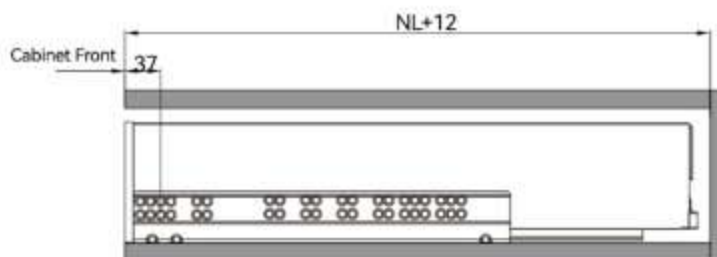

### Vágási méretek (18mm)

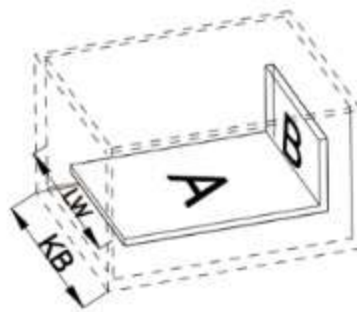
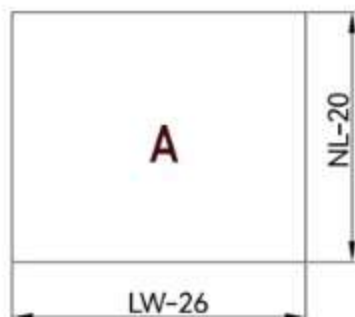

H	HT
94	60
135	101
182	148
217	183

A - Fenéklap vágási méretei    B - Hátlap vágási méretei    H - Káva magassága

KB - Szekrény külső mérete    LW - Szekrény belső mérete    NL - Nominális hosszúság    HT - hátlap magassága

## Előlap felszerelése

H94/H135

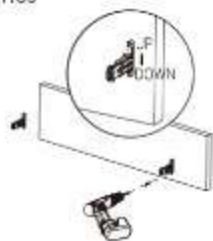

H182/H217

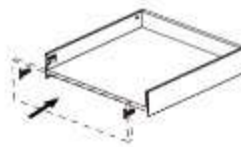
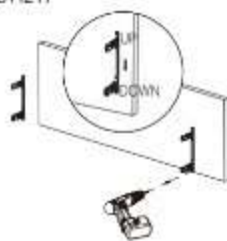

## Előlap leszerelése

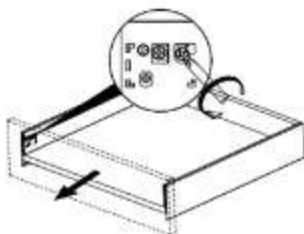
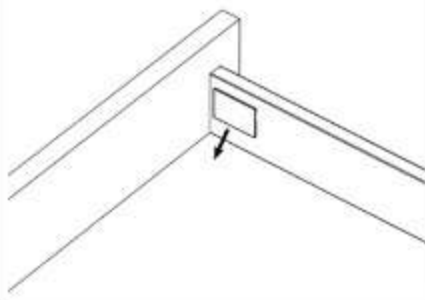

## Előlap állítási lehetőségei

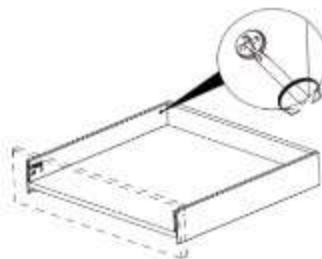
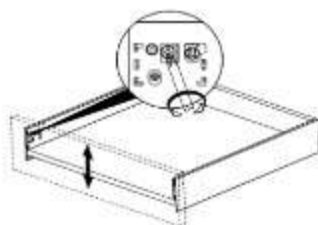
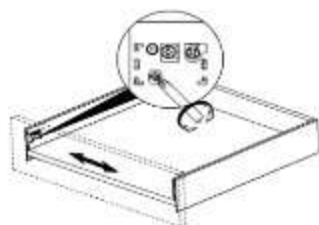

Előlap vízszintes állítása +/- 1,5mm    Előlap függőleges állítása +/- 1,5mm    Dőlésszög állítása +3,5 / -1,5

## Fiók berakása

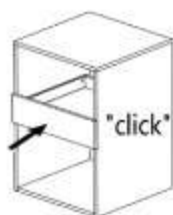
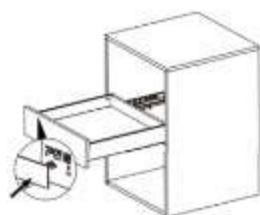

"click"

## Fiók kivétele

